

Merlin RG Series

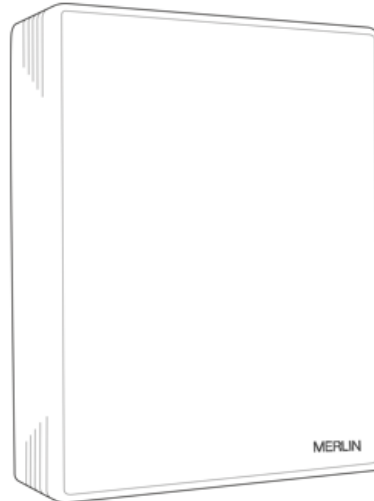

VRF Refrigerant Gas Sensor



INSTALLATION & OPERATION

Please read these instructions carefully before use and retain for future reference.

These instructions can also be downloaded in electronic form on the product website.



americangassafety.com

















CONTENTS

IMPORTANT INFORMATION	3
Manufacturer’s Warranty	3
INSTALLATION	4
General Information	4
Positioning	4
Mounting Instructions	5
PCB Overview	5
Power Wiring	6
+10V Output Wiring	6
VFC Relay Wiring	7
Thermistor Wiring	7
RS-485 Wiring	7
Analog Configuration Switches	8
Digital RG-485 Configuration Switches	8
OPERATION	9
RG Warning Levels	9
LED Indicator	9
Calibration Check	10
TECHNICAL SPECIFICATION	11

IMPORTANT INFORMATION



Take extra care where this symbol is used to understand the nature of any potential hazards and how to avoid them.

-  Before any installation, use or maintenance, read this manual carefully.
-  This product is for Dry Environment Use only.
-  Avoid prolonged use in dusty environments.
-  The information contained within this manual should be referred to for typical installation and operation only.
-  For site specific requirements that may deviate from the information in this manual – contact your supplier.
-  If the equipment is used in a manner not specified by the manufacturer, the safety and protection provided by the equipment may be impaired.
-  Installation must be in accordance with recognised standards in the country concerned.
-  The PCB contains circuitry that can be damaged by static discharge.
-  When metal conduit is used provision shall be provided by the installer for bonding in accordance with the NFPA70.
-  Cables must be protected against mechanical damage.
-  This product is not designed to detect smoke, fire or other gases and should NOT be used as such.
-  This device requires a continual supply of electrical power – it will not work without power.
-  A switch or circuit breaker must be fitted, it must be accessible and marked as the disconnecting device.
-  This product should not be used to substitute appropriate ventilation and exhaust systems.
-  This product may not safeguard individuals with specific medical conditions. If in doubt, consult a doctor / physician.
-  Your product should reach you in perfect condition, if you suspect it is damaged, contact your supplier.

Manufacturer's Warranty

The manufacturer warrants to the original consumer purchaser, that this product will be free of defects in material and workmanship for a period of 3 Years from the date of purchase.

The manufacturer's liability hereunder is limited to replacement of the product with repaired product at the discretion of the manufacturer. This warranty is void if the product has been damaged by accident, unreasonable use, neglect, tampering or other causes not arising from defects in material or workmanship. This warranty extends to the original consumer purchaser of the product only. Any implied warranties arising out of this sale, including but not limited to the implied warranties of description, merchantability and intended operational purpose, are limited in duration to the above warranty period. In no event shall the manufacturer be liable for loss of use of this product or for any indirect, special, incidental, or consequential damages, or costs, or expenses incurred by the consumer or any other user of this product, whether due to a breach of contract, negligence, strict liability in tort or otherwise. The manufacturer shall have no liability for any personal injury, property damage or any special, incidental, contingent, or consequential damage of any kind resulting from gas leakage, fire, or explosion. This warranty does not affect your statutory rights. During the above warranty period, your product will be replaced with a comparable product if the defective product is returned together with proof of purchase date. The replacement product will be in warranty for the remainder of the original warranty period or for six months – whichever is the greatest.

Disposing of Electrical & Electronic Equipment (WEEE)

When this product has reached the end of its life it must be treated as Waste Electrical & Electronics Equipment (WEEE). Any WEEE marked products must not be mixed with general household waste, but kept separate for the treatment, recovery and recycling of the materials used. Please contact your supplier or local authority for details of recycling schemes in your area.

INSTALLATION

General Information

 **Failure to observe the following may cause injury to persons and/or property.**

The RG detector series is to be installed in a permanent location and is intended to continuously monitor the ambient air for refrigerant levels.

Designed for all areas being directly connected to low or mains voltage supply, e.g., residential, public, commercial, and light industrial environments, which support the following outputs:

- **Analog:** 1x 0-10V signals for RG (PPM)
- **Digital:** RS-485 Modbus RTU or BACnet MS/TP communication protocols.
- **Relay:** VFC (RG): 1x SPST 70mA Max.

The equipment can operate as a standalone unit, be connected to a Merlin control panel or to other 3rd party devices capable of accepting digital and/or analogue signals, such as a Building Management System (BMS).

Installation must be carried out by a licenced and insured contractor, installed, and located in positions determined by those who have knowledge of refrigerant gas dispersion, process plant systems and any equipment involved. Seek advice where necessary, in consultation with both safety and electrical engineering personnel.

Consider air flow patterns within the area, the refrigerant detector must be installed in the correct orientation as per the manufacturer's specification, and ease of access should be accounted for to allow for any forms of maintenance throughout its operational life. For installations in North America, the National Electrical Code (NEC) should be strictly observed, and all appropriate local and national regulations should be observed.

Positioning

 **Position at a location with minimum noise, vibration, and environmental variation.**

 **Position in a discrete location away from busy walkways to avoid accidental damage.**

Recommended heights may vary based on airflow and temperature conditions in addition to the proposed application and location.

Due to refrigerant gasses being heavier than air and spreading downwards, the recommended installation height of a monitor should be **1 ft (30cm) from ground level.**

Observe the following also.

- The possible damage caused by natural events e.g., rain, flooding, falling debris.
- Any regulation/standard/code that locations are bound by.

Mounting Instructions

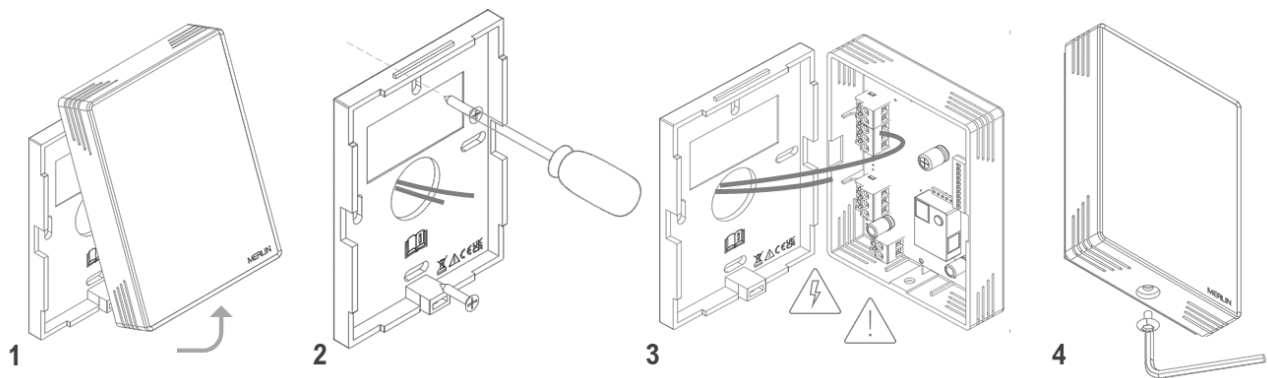

1. **Remove the front cover** by removing the screw underneath the housing using socket wrench provided.
2. **Mark mounting holes** ensuring surface is flat to avoid distortion. Using the backplate, mark points and drill 0.2" hole, insert plugs and use screws provided.
3. **Cable entry** is provided via rear 1/2" cut-out. Execute the mounting and connections.
NOTE: Terminals are pluggable type for ease.
4. **Secure the front cover** by aligning the top and then securing the M2 screw in place.

PCB Overview

- ⚠ All Class 2 wiring is to be installed within flexible tubing to maintain segregation between circuits.
- ⚠ Wiring of different circuits shall be separated by means of routing, clamping or barrier.
- ⚠ Strip cables as short as possible ensuring bare wires, e.g., wire shields, do not contact with the circuit board.

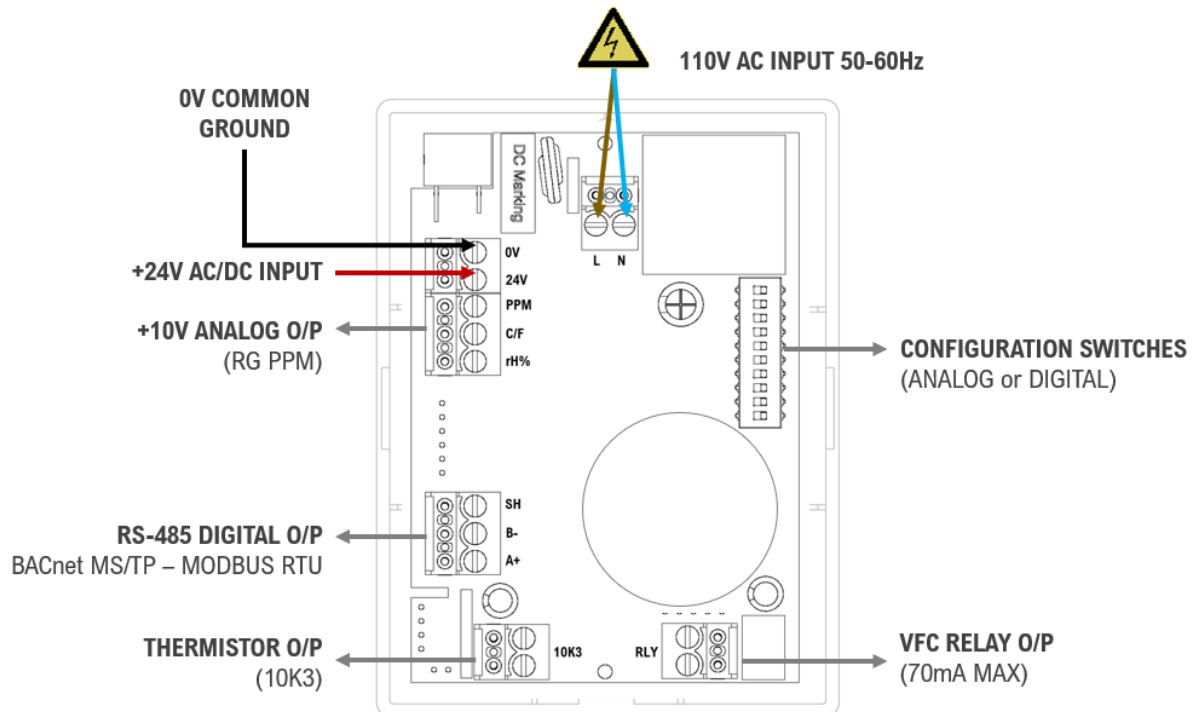

DISCLAIMER: For reference purposes only. All Diagrams and Connections depend on model.

Power Wiring

Consider voltage drops due to cable resistance and strip the cables as short as possible ensuring bare wires, e.g., wire shields, do not contact with the circuit board (risk of short-circuit).

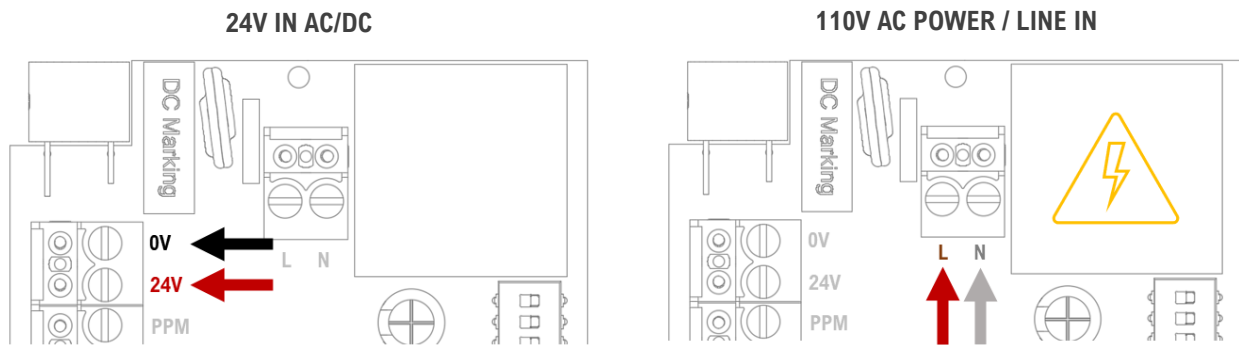

+10V Output Wiring

A linear +10V output is normally used to regulate external fan speed controllers (supplied separately).

The RG features a configurable 0/2-10V linear output for RG(PPM), the output of the device is proportional to the values.

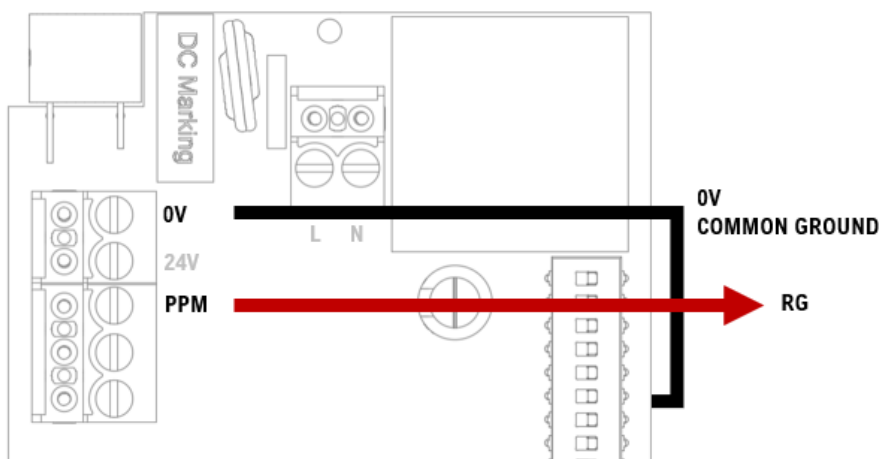

In normal operation, output levels are proportional to the gas level as shown below. Choose between 0-1000ppm or 0-5000ppm via the dipswitch on Analog models.

0-1000ppm	0-5000ppm	0-10V O/P	2-10V O/P
0%	0%	0V	2V
50%	50%	5V	6.0V
100%	100%	10V	10V

VFC Relay Wiring

This is a dry contact/volt free connection to a BMS (building management system) or central control panel to send an alarm signal upon the defined RG level. This terminal can be used in conjunction with other external relays that affect other devices, and controls such as purge fans, audible alarms, strobe/beacons etc.

As a factory set condition, the relay is Normally Closed when the device is energised and in normal operation (fail safe), ensuring relays are triggered upon a power failure.

Thermistor Wiring

This 2-way terminal provides an output for an NTC type thermistor fitted to the PCB. Other thermistor types are available, contact your supplier for more information.

RS-485 Wiring

- ⚠️ Ensure the equipment is configured in a single bus topology, connecting multiple buses in parallel or branching multiple units from the main bus, may introduce impedance mismatches, reflections and/or signal distortions.
- ⚠️ Ensure A+/B- signal polarity is maintained throughout the network.
- ⚠️ Connect GND wire to 0V common grounding terminal.

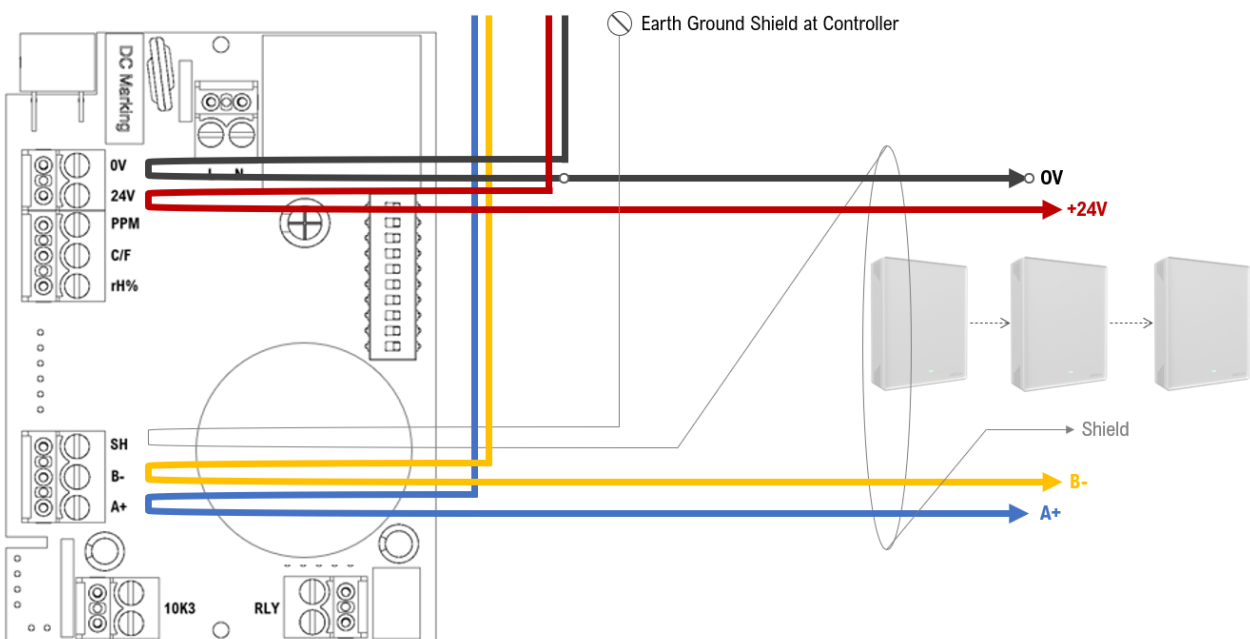

Daisy chain wires running to additional RG sensors – 127 sensors max per cable run. First and last device in bus requires a termination resistor. Use EOL switch to terminate RG sensor. Recommended 3-core, 2 twisted pair + ground, shielded cable with 120 Ω characteristic impedance.

Shield terminal [SH] is used to maintain shield line only. Shield is cut and taped on last device.

Consider voltage drops due to cable resistance for long distances/large networks. Cable specifications ultimately determine the distance the sensors can be mounted away from a control panel or power supply. Strip cables as short as possible.

See **RG BACnet or Modbus Functionality** Document for more information and parameterization.

Analog Configuration Switches

LABEL	ACTION	OPTION	DEFAULT
EOL	NOT USED		
1	(RG) Range*	ON: 0-1000 ppm OFF: 0-5000 ppm	OFF 5000ppm
2	(RG) Low Level Warning	ON: 175 ppm OFF: 350 ppm	OFF 350ppm
4	(RG) High Level Warning	ON: 800 ppm OFF: 1000 ppm	OFF 1000ppm
8	(RG) VFC Relay Position	ON: NO (Normally Open) OFF: NC (Normally Closed)	OFF (NC) Fail Safe
16	(RG) VFC Relay Switches at	ON: 800 ppm OFF: 1000 ppm	OFF 1000ppm
32	(RG) +10V Output Linear Scale	ON: 2-10V OFF: 0-10V	OFF 0-10V
64			
B1			
B2	NOT USED		

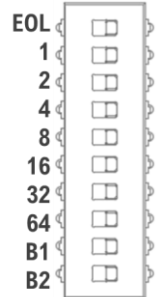







Digital RG-485 Configuration Switches

LABEL	ACTION	OPTION	DEFAULT
EOL	END OF LINE TERMINATION RESISTOR.		OFF
1	NETWORK ADDRESS	Address achieved by adding binary switch values together. 4 ON + 16 ON = ADDRESS 20 8 ON + 32 ON + 1 ON = ADDRESS 41 Address Max: 127	OFF (Address 0)
2			
4			
8			
16			
32			
64			
B1	BAUD RATE SELECTION	Baud rates achieved by configuring B1 and B2 switches. B1 OFF / B2 OFF = 9600 B1 OFF / B2 ON = 38400 B1 ON / B2 OFF = 19200 B1 ON / B2 ON = (76800 - BACnet) (57600 - Modbus)	B1 OFF B2 OFF (9600)
B2			

 **If the address value conflicts with another device, neither device will be able to communicate.**

OPERATION

RG Warning Levels

-  Before leaving the device for normal operation, check configuration for proper settings.
-  After connecting power, the device will enter a warm-up period to allow the device to establish connections and sensor elements to stabilize before a valid reading/output.
-  RG warning levels will depend on configuration at install.
-  Avoid sudden temperature changes, above 1°C per minute.
-  Never let water or other liquids to enter inside the sensor.
-  Never expose the sensor to corrosive gases.

PPM = Parts Per Million

RG Range	OK	Low RG Warning	High RG Warning
0 - 5000ppm (Default)	< 175ppm (Default)	175 – 1000ppm (Default)	> 1000ppm (Default)

LED Indicator

- **GREEN** = RG Level OK / Power Supplied
- **YELLOW** = RG Level Warning (LOW)
- **RED** = RG Level Warning (HIGH)

Calibration Check





Due to the advance NDIR technology no field calibration is required.

A regular calibration check by trained technicians is recommended. Inspections and services must be documented and executed at regular intervals. The frequency must be determined and observed by the person responsible for the gas warning system according to all regulatory, code and legal requirements. The inspection interval of 12 months to retain optimum safety is recommended following the below precautions.

- Ensure the unit has been powered for 1 hours in a clean environment for stabilised measurement results.
- Flow some dry air into the monitor for 5min before testing.
- A suitably calibrated gas mix bottle should be used observing the precautions listed below, the gas flow used for testing should be ≤ 500 SCCM (0.5 LPM).
- Offer up the applicator hose with a 32mm cone that can be supplied from AGS on request. Apply the cone directly over the sensing element.
- Apply the gas and check it is being correctly measured and reaching any set alarm points.
- The calibration result and date should be recorded.



Test Gases Precautions

-  Use calibration test gases that are classified as non-flammable and non-toxic, however, gas under pressure may explode if heated and cause asphyxiation in very high concentrations.
-  Gas mixtures must be prepared using equipment traceable to N.P.L / ISO standards.
-  Take normal precautions when using cylinders, they should always be stored in the vertical position and secured to prevent them from falling over.
-  Ensure valve/regulators are screwed and secured tight before use and ensure valves are closed after use.

TECHNICAL SPECIFICATION

Mechanical	Mounting	Wall Mounted
	Entry	1" DIA Rear Entry and snap offs for side trunking
	Size (W x H x D)	3.38 x 4.48 x 1.3"
	Weight (Max)	36oz Max
	Enclosure	ABS UL Flame retardant – IP40
Electrical	24V AC/DC Power Rating	12-24VDC (11-32 VDC) / 24VAC, (20-27 VAC) 60Hz
	110VAC Power Rating	Nominal 110-120VAC, (90-250V AC), 50-60Hz
	Internal Fuse	Resettable PPTC 240VAC, 400mA
	Communication	127 units max
	Power Consumption Max	5W Max
Environmental	Operating Temperature	14 to 122°F
	Storage	32-86°F
	Humidity	0 to 95% RH (continuous) non-condensing.
	Installation Cat (110V Voltage)	II (Class 2) Pollution Degree 2
	Installation Cat (24V Voltage)	III (Class 3) Pollution Degree 2
I/Os	Analog Outputs	3x Linear 0-10V/2-10V RG, Temperature & Humidity. Thermistor (10K3)
	Digital Networks	BACnet MS/TP / MODBUS RTU (Parity: None Data bit: 8bit Stop bit: 1)
	Relay Outputs	1x SPST 70mA
Cable Spec	Power	18 – 14 AWG
	Analog Output	18 – 14 AWG
	Digital Output	18 – 14 AWG twisted pair + ground, shielded cable with 120 Ω characteristic impedance.
	Relays	18 – 14 AWG
	User Interface	Language
LED Indication		Green: Power (OK) Yellow: Warning (Pre-Alarm) Red: Danger (Alarm)
Conformance	Safety	IEC 61010-1
	Electromagnetic Compatibility	BS 50270
	Other (Applied or Considered)	
Sensing		
Refrigerant Gas (ppm)		
<p>Sampling: Diffusion Type NDIR</p> <p>Indication Range: 0– 10,00ppm Gas type dependant.</p> <p>Response: T50 ≤ 10 s; T90 ≤ 30 s</p> <p>Warm Up Time: ~1 Minute</p> <p>Accuracy: 50% F.S ±7% of FS range above 50% F.S</p> <p>Lifespan: >5 Years</p> <p>Resolution: 0.5% of F.S range</p>		

Please pass this manual to the system owner / user.

Date of Installation:	
Installation Location:	
Organisation:	
Stamp/Signature of the installer:	

We recommend all AGS equipment be commissioned by competent/trained engineers to ensure correct installation and operation. We strongly recommend the response and alarm signals are tested and validated once installed. This will ensure the equipment performs as intended and is free from any unforeseen damage caused by transit/installation.

Every effort is made to ensure the accuracy of this document; however, AGS can assume no responsibility for any errors or omissions in this document or their consequences. AGS would greatly appreciate being informed of any errors or omissions that may be found in the content of this document. For information not covered in this document, or if there is a requirement to send comments/corrections, please contact AGS using the contact details given below.

American Gas Safety LLC

www.americangassafety.com

Head office:

6304 Benjamin Road, Suite 502, Tampa, FL 33634

Tel: (727) 608-4375

Email: info@americangassafety.com



American Gas Safety LLC is the owner of this document and reserves all rights of modification without prior notice.