

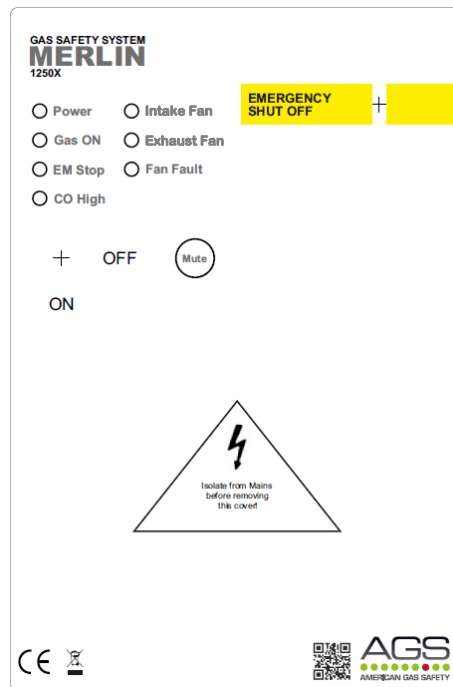

Merlin 1250X

Gas & Ventilation Interlock System



Installation, Operation & Maintenance Manual

Please read this manual carefully and retain for future use.

The Merlin 1250X is a ventilation interlock panel for up to 2 fans. It has built-in current monitoring and is designed for use with fans up to 18A running current (0.1A minimum) and also has the ability to receive connections from external current monitors or air pressure differential switches.

Information contained within this manual should be referenced for typical installation and operation only. For specific requirements that may deviate from the information in this guide – contact your supplier!

Contents

IMPORTANT WARNING STATEMENTS	3
INSTALLATION	4
Planning	4
Mounting	4
Board Connections	5
Board Connections Overview	5
Access Configuration Settings	6
Configuration Settings Explained	6
Fan Calibration	7
Fan Dropout Threshold Values.....	7
Specification.....	8
OPERATION.....	9
First Power Up.....	9
LED Indicator Status	9
Mute Button.....	9
System Diagnostics.....	10
MAINTENANCE	10
Cleaning and General Advice	10



IMPORTANT WARNING STATEMENTS

Please take the time to thoroughly read this user's guide which should be retained for future reference.

It is recommended that this device be commissioned upon installation.

Do not apply lighter gas or other aerosols to external gas detectors or monitors – this can cause extreme damage to the gas sensing elements.

High concentrations of alcohol found in many products may damage, deteriorate or affect the gas sensing elements of detectors – Avoid exposure near your devices and follow the manufacturing instructions.

Never ignore your devices when in alarm. Actuation of your alarm indicates the presence of an error or issue that requires immediate attention.

This device requires a continual supply of electrical power – it will not work without power.

This device should not be used to substitute proper installation, use and/or maintenance of fuel burning appliances including appropriate ventilation and exhaust systems.

Your product should reach you in perfect condition, if you suspect it is damaged, contact your supplier.

MANUFACTURERS WARRANTY

Warranty coverage:

The manufacturer warrants to the original consumer purchaser, that this product will be free of defects in material and workmanship for a period of three (3) years from date of purchase. The manufacturer's liability hereunder is limited to replacement of the product with repaired product at the discretion of the manufacturer. This warranty is void if the product has been damaged by accident, unreasonable use, neglect, tampering or other causes not arising from defects in material or workmanship. This warranty extends to the original consumer purchaser of the product only.

Warranty disclaimers:

Any implied warranties arising out of this sale, including but not limited to the implied warranties of description, merchantability and intended operational purpose, are limited in duration to the above warranty period. In no event shall the manufacturer be liable for loss of use of this product or for any indirect, special, incidental or consequential damages, or costs, or expenses incurred by the consumer or any other user of this product, whether due to a breach of contract, negligence, strict liability in tort or otherwise. The manufacturer shall have no liability for any personal injury, property damage or any special, incidental, contingent or consequential damage of any kind resulting from gas leakage, fire or explosion. This warranty does not affect your statutory rights.

Warranty Performance:

During the above warranty period, your product will be replaced with a comparable product if the defective product is returned together with proof of purchase date. The replacement product will be in warranty for the remainder of the original warranty period or for six months – whichever is the greatest.



INFORMATION ON WASTE DISPOSAL OF ELECTRICAL & ELECTRONIC GOODS

When this product has reached the end of its life it must be treated as Waste Electrical & Electronics Equipment (WEEE).

Any WEEE marked products must not be mixed with general household waste, but kept separate for the treatment, recovery and recycling of the materials used. Please contact your supplier or local authority for details of recycling schemes in your area.

INSTALLATION

Planning

The Merlin 1250X is a ventilation interlock panel for up to 2 fans.

The Merlin 1250X has built-in current monitoring and is designed for use with fans up to 18A running current (0.1A minimum), it also has the ability to receive connections from external current monitors or air pressure differential switches.

For ease of setting up, the Merlin 1250X has an internal display to facilitate calibration of the current monitors, setting thresholds and diagnostics. To meet the latest guidance, the Merlin 1250X includes connections for a CO (Carbon Monoxide) monitor along with remote emergency stop connections.

Selectable panel features include;

- ✓ Dual fan current monitoring from 0.1 to 18A;
- ✓ Connections to remote emergency shut off;
- ✓ Fan calibration and current monitoring including diagnostics.



Please refer to your manufacturer's instructions for important information regarding coverage, location and positioning including areas and conditions to avoid!

Mounting

Unpack all the parts!

Place the panel 48-60 inches above finished floor level for ADA compliance.

1. Carefully remove the front cover from the unit by unscrewing the four bolts located at each corner. To do this – use the socket wrench provided.
2. Remove the power board from the back enclosure.
3. Mark four screw holes located on the back of the enclosure to the wall. Ensure the wall surface is flat to prevent base distortion.
4. After executing the mounting and the connections – replace the front cover and insert the security caps over the four bolts.



*Be careful when creating access for cables – Damage to boards will void any warranty!
Any damage attempting to remove the circuit board parts may void any warranty!*

A flush mount kit is available, comprising of a mounting bracket and decorative surround strip. Contact your supplier for more information.

Board Connections

⚠ WARNING!

To avoid electrical shock you must always isolate the line supply before opening the panel!
 Take care when making connections to high voltage connectors!
 Avoid running mains wiring across the circuit board!
 Any damage attempting to remove the circuit board may void any warranty!
 Separate different circuits from each other by means of routing, clamping or barrier!
 To avoid electrical interference, avoid installation near to fan speed controllers!

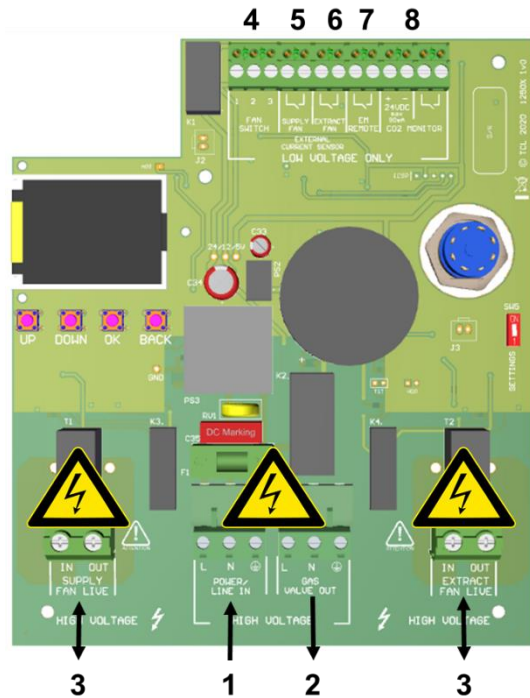

Board Connections Overview

1. POWER / LINE IN.

100-120Vac power input should be supplied and fused at 3A.

2. GAS VALVE OUT.

100-120Vac power output is supplied from the [GAS VALVE OUT] terminal using a 3 core cable can be connected to a gas solenoid valve. The gas valve will shut off the supply in any error condition. Refer to your valve manual for more information.

3. CURRENT MONITOR [INTAKE FAN LINE] & [EXHAUST FAN LINE].

The line voltage supply feed from the fan controller should be connected to either the intake or exhaust side depending on which fan/s are being monitored. Each will monitor its own independent fan.

From a fan controller the line voltage supply feed should be taken to the [IN] terminal and the [OUT] terminal should wire to the fan motor controller. **Max 18A.**

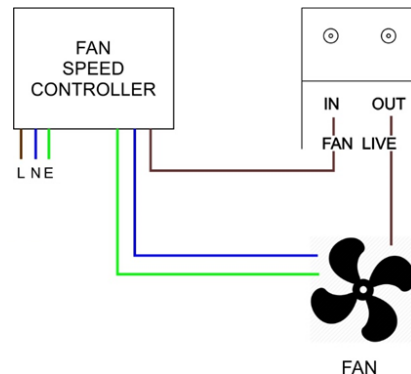

4. FAN SWITCH 1,2,3

This terminal switches when the key is turned on and off. This can be linked to a fan switch (panel supplied separately) which can provide power to the fans when the control panel is switched on.

**5. EXTERNAL CURRENT SENSORS
[INTAKE FAN] & [EXHAUST FAN]**

These terminals are used to receive an input signal from external air pressure switches or external current monitors. These are linked out as a factory setting to represent a closed circuit.



If only one fan is being used, the terminal not in use should be left closed!

6. EM REMOTE.

Open/Close circuit connections for external devices is marked as [EM STOP] and can shut off the gas supply when activated. This is fitted with a factory link to represent a closed circuit.

7. 24V DC for CO MONITOR & OPEN/CLOSE CIRCUIT

This is a permanent power output for CO Monitor. (Sold Separately)

Max output: 90mA. A Merlin CO monitor can shut off the gas supply if high concentrations of Carbon Monoxide is detected.

Refer to your manufacturers CO monitor instructions.

Access Configuration Settings

On the front fascia circuit board you'll find a [SETTINGS] dip-switch – when switched ON (before turning the panel on) via the key switch, the screen will display the settings menu – you can now configure your panel.

To view, change and save settings, you must provide mains power.

There are four buttons, press to navigate through the settings and configure the system. To select functions and change options;

- navigate functions by pressing [UP] or [DOWN];
- press [OK] to select options;
- press [UP] or [DOWN] to change option setting;
- press [OK] to save option or [BACK] to return to function.

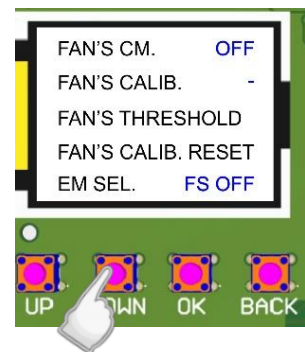

When changes have been made – turn the SETTINGS switch OFF and restart the key switch!

Configuration Settings Explained

Default Settings Shown



Page 1

FAN'S CM.	OFF
FAN'S CALIB.	-
FAN'S THRESHOLD	
FAN'S CALIB. RESET	
EM SEL.	FS OFF

Fan Threshold

THRESHOLD	[%]
INTAKE MIN.	10
INTAKE MAX.	10
EXHAUST MIN.	10
EXHAUST MAX.	10

Fan Calibration

TO EXIT PRESS BACK		
INT. 	TO SWITCH FAN USE OK	EXTR. 
	[A]	0.00
—	MAX.	—
—	MIN.	—
TO CALIB. MAX. PRESS UP TO CALIB. MIN. PRESS DOWN		

FUNCTION	OPTION	Explanation
FANS CM.	- OFF - ON - INT ONLY - EXT ONLY	Combination of fan current monitoring. Select either current monitoring OFF , current monitoring for both Intake and Exhaust ON or either Intake or Exhaust only .
FANS CALIB.	- - OK	If fans are calibrated, this will be set as ' OK '. See section: Fan Calibration to calibrate fans.
FANS THRESHOLD %	- 10 - 20 - 30 - 40	Dropout threshold for Min and Max current values of both intake and exhaust fans. It is possible to select between a= 10% to a 40% dropout threshold if required. You will need to recalibrate fans after changing dropout thresholds. See section: Fan Dropout Threshold Values.
FANS CALIB. RESET	- NO - YES	Remove and reset any saved fan calibration settings – YES . See Section: Factory Set Condition
EM SEL.	- FS OFF - FS ON	When Emergency Shut Off button pressed: <ul style="list-style-type: none"> • FS OFF the Fan Switch (FS123) relay will be shut OFF. • FS ON the Fan Switch (FS123) relay will stay ON.

Fan Calibration

Select [FANS CALIB.] in the settings menu.

1. Press [OK] to switch to intake (INT.) or exhaust (EXTR.) fan. Fan selection highlighted yellow.
2. Wait for the current value to appear (A). Press [UP] button to calibrate highest fan current. If successful, 'OK' appears on screen (MAX.)
3. Press [DOWN] button to calibrate low fan current. If successful, 'OK' appears on screen (MIN.) Fan icons switch from black to green.

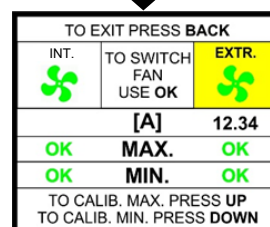
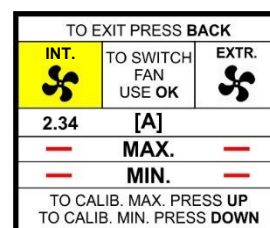

If calibration is unsuccessful then alter fan dropout thresholds in the settings menu and repeat.

Fan Dropout Threshold Values

When [FANS THRESHOLD] is selected in the settings menu, the user can adjust the minimum and maximum current values by 10, 20, 30 or 40%. Fans with a current between 0.1 to 0.2A we recommend a dropout threshold ≥ 30%.

Threshold MAX value (%)	10	20	30	40
Running current (Max.)	18A	16.5A	15A	14A



If calibration is successful it is possible to change the fan threshold without recalibration.

Fans new threshold automatically recalculates min and max current fan fault values.

The 1250X can display fan currents (amp) in the diagnostic screen. See section: Diagnostics

Specification

Model:	1250X
Display	1.8" Screen TFT (located inside)
Power Input Voltage	100-120Vac
Gas Valve Output Voltage	100-120Vac
Single phase AC current monitor calibration range	0.1 – 18 Amps
Single phase AC current monitor display	0 - 22Amps
Power Consumption	4.6 W (Panel), 5W max (fully loaded)
Internal Fuse	3.15A
Ingress Protection	IP54
Operating Temperature & RH	0 – 50°C (32 – 122°F) 30-85%RH Non-Condensing
Approvals	CE
Audible Alarm Buzzer dB	70 dB (300mm distance in quiet conditions)
O/All Dimensions (H x W x D) mm	255 x 180 x 77mm

OPERATION

First Power Up

1. Supply 100-120Vac power, the 'Power' LED on the front of the panel will illuminate.
2. Turn external fans on.
3. Turn the panel key switch on to start the system.
4. Turn the key switch off to turn off the system.

LED Indicator Status

- **Power**

On when mains power is supplied.

- **Gas ON**

When fans are running at correct speed, the key switch is turned on and there are no error conditions the gas valve will open and the Gas ON LED will illuminate. ON = Gas supplied OFF = Gas Isolated.

- **EM Stop**

If an emergency shut off button (either remote or on the panel) is pressed, the LED will illuminate and the gas supply will be isolated. Any shut-off buttons must be reset before restarting the system.

- **CO High**

If the concentration of CO in the air is at alarm level (relevant detector required), the LED will illuminate and the gas supply is isolated.

- **Intake Fan** - Under normal working conditions this LED is on.

*If a intake fan **external current sensor fault** is detected, the LED will flash.*

After ~20 seconds: the LED will remain on and Fan Fault LED will illuminate.

*If a intake fan **internal current monitor fault** is detected, the LED will flash.*

After ~20 seconds the LED will flash twice a second and Fan Fault LED will illuminate.

- **Exhaust Fan** - Under normal working conditions this LED is on.

*If an exhaust fan **external current sensor fault** is detected, the LED will flash.=After ~20 seconds: the LED will remain on and Fan Fault LED will illuminate.*

*If an exhaust fan **internal current monitor fault** is detected, the LED will flash.=After ~20 seconds the LED will flash twice a second and Fan Fault LED will illuminate.*

- **Fan Fault**

If a fan fault occurs for longer than 20 seconds, the LED will illuminate RED.

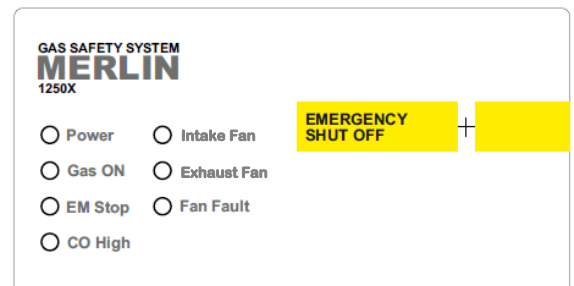

Mute Button

Pressing the 'Mute' button on the front of the 1250X panel will silence the internal buzzer when in alarm status e.g. Emergency Stop activated, CO High etc.



System Diagnostics

The panel can display fan current (Amps).

To view these diagnostics, carefully remove the front fascia of the panel, to activate screen diagnostics, press either the [OK], [UP] or [DOWN] button.



The diagnostic screen is available during; proving status; normal operation; fan fault and pressure low status.

The screen will automatically enter sleep mode after 10 minutes of inactivity or when the [BACK] button pressed.



DIAGNOSTICS	
SUPP.	EXTR.
	
2.34	12.34
A	A



Contact with mains electrical power can be fatal!

L DIAGNOSTICS	
SUPP.	EXTR.
	
0.34	12.34
A	A

L = Fan Current is: < minimum calibrated value!

DIAGNOSTICS H	
SUPP.	EXTR.
	
2.34	15.34
A	A

H = Fan Current is: > maximum calibrated value!

MAINTENANCE

Cleaning and General Advice

Keep your system in good working order follow these basic principles;

- Remove any dust/debris from the outer enclosure regularly using a slightly damp cloth.
- Never use detergents or solvents to clean your gas detection devices.
- Never spray air fresheners, hair spray, paint or other aerosols near devices.
- Never paint devices. Paint will seal vents and interfere with the device.



It is recommended that detectors are inspected and serviced at least annually from the date of installation for optimum performance and protection due to sensitivity drifts!



High concentrations of alcohol found in many products may damage, deteriorate or affect the gas sensor such as; wine; deodorants; stain removers; thinners etc. Other gases and substances to avoid are; Corrosives (i.e. chlorine & hydrogen chloride); Alkali metals; Basic or acidic compounds; Silicones; Tetraethyl lead; Halogens and halogenated compounds!

ENGINEERING NOTES – Blank Page

INSTALLATION DETAILS

Please pass this manual to the system owner or system user.

Date of Installation:	
Installation Location:	
Organisation:	
Stamp/Signature of the installer:	

CONTACT US:

AGS Head Office

Tel: (727) 608-4375

Fax: (727) 538-4237

info@americangassafety.com



American Gas Safety is the owner of this document and reserves all rights of modification without prior notice.