

TECHNICAL MANUAL

Installation, Operation & Maintenance



AGS PARKSAFE Detector

Carbon Monoxide (CO) & Nitrogen Dioxide (NO₂)



American Gas Safety LLC
www.americangassafety.com

Content

Safety Information	3
General	3
Information on waste disposal for consumers of electrical & electronic equipment.	3
Installation	4
Introduction.....	4
Typical Monitoring System.....	4
ParkSafe Detector Placement Plan	4
Mounting the ParkSafe Detector	5
Main Board Overview.....	6
Wiring a ParkSafe Detector.....	6
Wiring a ParkSafe Detector Chain.....	7
ParkSafe Detector 'ID' Switches	7
120ohm Termination Resistance.....	7
Manual Circuit Test.....	8
Operation	8
First Power Up	8
LED Indications	8
Gas Detector Alarm Set Points.....	8
Maintenance	9
Cleaning.....	9
Manual Circuit Simulation Test	9
Annual Service Message.....	9
End of Operational Life (EOL)	9
Bump Testing (Gas Response Check)	10
Standard Test Gases.....	10
Bump Test Procedure.....	10
Technical Specification	12

Safety Information

General

- ⚠ Ensure that this manual is read and understood before installing / operating / maintaining the equipment.
- ⚠ The information contained within this manual should be referenced for typical installation and operation only.
- ⚠ For site specific requirements that may deviate from the information in this guide – contact your supplier.
- ⚠ If the equipment is used in a manner not specified by the manufacturer, the safety/protection provided by the equipment may be impaired.
- ⚠ This device is designed for indoor operation only.
- ⚠ It is recommended that this device be commissioned upon installation and serviced annually.
- ⚠ This equipment is designed to detect carbon monoxide and nitrogen dioxide when PARKSAFE detectors are used. Sold separately.
- ⚠ It is NOT designed to detect smoke, fire or other hazards and should NOT be used as such.
- ⚠ This device provides early warning of the presence of nitrogen dioxide or carbon monoxide when PARKSAFE detectors are connected, usually before a healthy adult would experience symptoms.
- ⚠ This early warning is possible provided your alarm is located, installed and maintained as described in this manual.
- ⚠ This device requires a continual supply of electrical power – it will not work without power.
- ⚠ This device should not be used to substitute proper installation, use and / or maintenance of fuel burning appliances including appropriate ventilation and exhaust systems.
- ⚠ This device does not prevent nitrogen dioxide or carbon monoxide from occurring or accumulating.
- ⚠ Actuation of your alarm indicates the presence of dangerous levels of NO₂ or CO.
- ⚠ Seek fresh air supply and contact your local gas emergency service should you suspect a gas leak.
- ⚠ This device may not fully safeguard individuals with specific medical conditions.
- ⚠ If in doubt, consult a doctor / physician.
- ⚠ Your product should reach you in perfect condition, if you suspect it is damaged, contact your supplier.
- ⚠ Concentrations of alcohol found in many products may damage, deteriorate or affect the gas sensing elements such as; wine; deodorants; stain removers and thinners. Other gases and substances to avoid are; corrosives (i.e. chlorine & hydrogen chloride); alkali metals; basic or acidic compounds; silicones; tetraethyl lead; halogens and halogenated compounds!

Information on waste disposal for consumers of electrical & electronic equipment.



When this product has reached the end of its life, treat as Waste Electrical & Electronics Equipment (WEEE).

Any WEEE marked products must not be mixed with general household waste, but kept separate for the treatment, recovery and recycling of the materials used. Please contact your supplier or local authority for details of recycling schemes in your area.

- ⚠ At the end of their working life, electrochemical sensors for PARKSAFE detectors should be disposed of in an environmentally safe manner. Alternatively, all detectors can be securely packaged and returned to AGS clearly marked for disposal.
- ⚠ Electrochemical sensors should not be incinerated as this may cause the cell to emit toxic fumes.

Warranty Statement

All products are engineered, designed and 100% quality tested in accordance with the latest internationally recognised standards under a Quality Management System that is certified to ISO 9001. The manufacturer warrants to the original consumer purchaser, that this product will be free of defects in material and workmanship for a period of three (3) years from date of purchase. The manufacturer's liability hereunder is limited to replacement of the product with repaired product at the discretion of the manufacture. This warranty is void if the product has been damaged by accident, unreasonable use, neglect, tampering or other causes not arising from defects in material or workmanship. This warranty extends to the original consumer purchaser of the product only.

Any implied warranties arising out of this sale, including but not limited to the implied warranties of description, merchantability and intended operational purpose, are limited in duration to the above warranty period. In no event shall the manufacturer be liable for loss of use of this product or for any indirect, special, incidental or consequential damages, or costs, or expenses incurred by the consumer or any other user of this product, whether due to a breach of contract, negligence, strict liability in tort or otherwise. The manufacturer shall have no liability for any personal injury, property damage or any special, incidental, contingent or consequential damage of any kind resulting from gas leakage, fire or explosion. This warranty does not affect your statutory rights.

During the above warranty period, your product will be replaced with a comparable product if the defective product is returned together with proof of purchase date. The replacement product will be in warranty for the remainder of the original warranty period or for six months – whichever is the greatest.

Installation

Introduction

- ⚠ Installation must be in accordance with the recognised standards of the appropriate authority in the country concerned!
- ⚠ Access to the interior of the detector, when carrying out any work, must only be conducted by trained personnel!
- ⚠ Before carrying out any work ensure local regulations and site procedures are followed!

In parking structures, CO and NO2 are two of the most abundant airborne contaminants and poses significant safety concerns. The CO and NO2 levels must be controlled or ventilated when concentrations approach hazardous levels.

The PARKSAFE Controller is designed for installation into car parking facilities and enclosed garages and paired with AGS PARKSAFE Detectors (Nitrogen Dioxide and Carbon Monoxide) that will be linked via Modbus RTU protocol back to the controller and monitor the detectors in numbers up to 16 (per controller) and automatically control ventilation systems according to gas levels and an optional temperature level. The PARKSAFE Controller monitoring system is capable of activating both the exhaust fan(s) and the air intake device(s) such as outside air louvers/dampers and make up air units.

Take in to account the design of the air flow patterns within the parking zone area. Detectors should be installed in the correct orientation, as recommended by the manufacturer, and ease of access should be accounted for to allow for any bump tests and other forms of maintenance and identification.

Typical Monitoring System

- ⚠ The use of sound strobes is highly recommended!
- ⚠ Consult local codes for the specific requirements!
- ⚠ The quality of the data signals will vary depending on cable size, number of detectors, the quality and length of the cable run. Where connections may exceed 500 yards from one control panel. Contact your supplier should issues occur!

Addressable PARKSAFE detectors are daisy-chained through a RS485 RTU communication protocol to the controller.

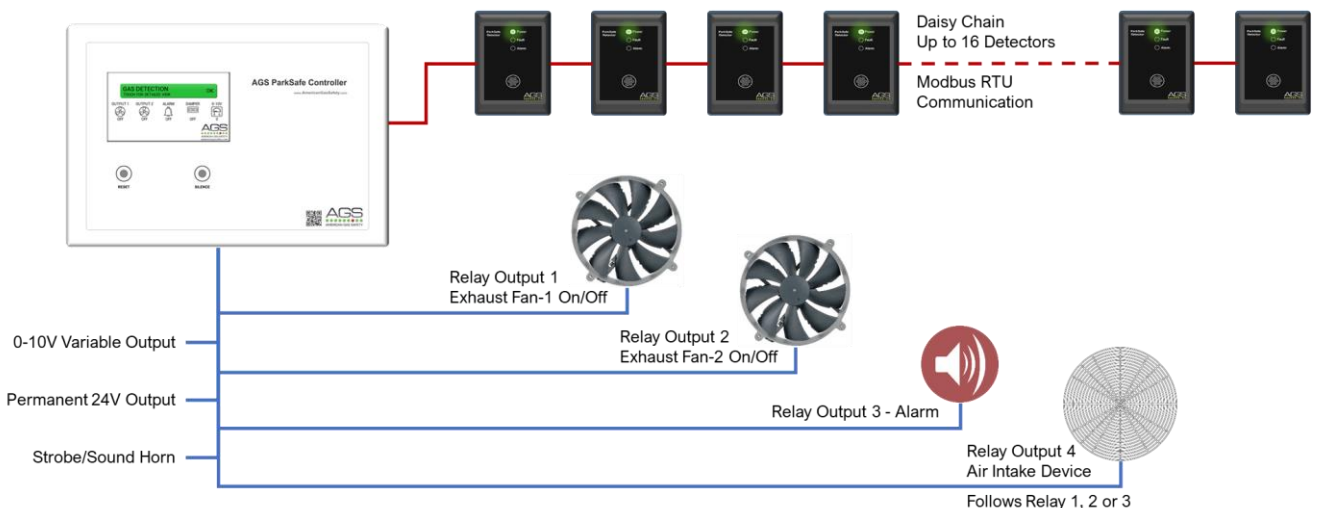

ParkSafe Detector Placement Plan

The relative density of carbon monoxide compared to air of carbon monoxide is 0.957 (AIR =1). The carbon monoxide will disperse evenly in the air. The carbon monoxide monitors must be located as specified by your region’s building code. If not specified contact your local AGS representative.

Detection of nitrogen dioxide is done where a significant quantity of diesel engines typically are located such as train stations, bus and truck maintenance garages, rapid transit authorities, car dealerships, ambulance bays, loading docks and diesel-powered vehicle parking structures.

PARKSAFE detectors should be mounted where a potential hazard of gas is most likely to be present. The following points should be noted when locating gas sensors. When locating detectors consider

- The possible damage caused by natural events e.g. Rain or flooding.
- Ease of access to the gas detector for functional testing and servicing.
- How gas may behave due to natural or forced air currents.

The quantity of sensors is determined by the following rules of thumb:

1. The radius of coverage is approx. 50-100m² per Detector or 538 - 1076 sq ft
2. Use open interior support columns as much as possible to maximize the radius of coverage.
3. Each level of the parking structure must be totally covered without overlapping the coverage of the sensors.

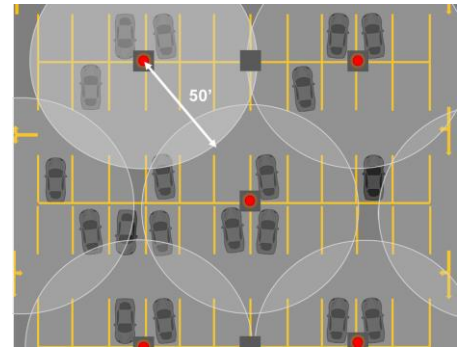

If in doubt, contact your local AGS representative.

Mounting the ParkSafe Detector

Unpack all the parts! Designed for surface mounting, it must be installed by a licensed, insured contractor.

Carefully remove the front cover of the unit by removing the four screws with a screwdriver. Remove the foam, this is used for transit purposes only. Using the rear cover - mark the screw holes to the wall. If mounting direct to wall - ensure the wall surface is flat to prevent base distortion. There is a 0.79" diameter hole for cable entry. Position as per the recommended heights and in accordance with applicable local/national regulations.

After executing the mounting, connections and ID switches – secure the front cover.



Locations for PARKSAFE gas detectors will vary based on the intended application and target gas, they should be located near where hazardous gas could quickly accumulate and areas of identified consequential risk. The composition of the target gas and its density relative to air are used as the basis for the recommended height of gas detectors. These heights may vary based on air flow and temperature conditions in addition to the proposed application and location.

- **Carbon Monoxide (CO) gas** 4-6ft from ground level.
- **Nitrogen Dioxide (NO₂) gas** 4-5ft from ground level to avoid damage by car bumpers, doors etc.

Avoid conditions of any other environmental factors that could potentially impede the accuracy and operation of the detectors such as; condensation; vibration; temperature, pressure, the presence of other gases, electromagnetic interference and draft areas.

Main Board Overview

- ⚠ Be careful when creating access for cables – Damage to circuit boards will void any warranty!
- ⚠ Any damage attempting to remove the circuit board parts may void any warranty!
- ⚠ Detectors must be grounded for electrical safety and to limit the effects of EMC or R/F interference!
- ⚠ For MODBUS communications, a shielded cable is used!
- ⚠ Do not remove the Gas Sensor Module when the detector is powered!

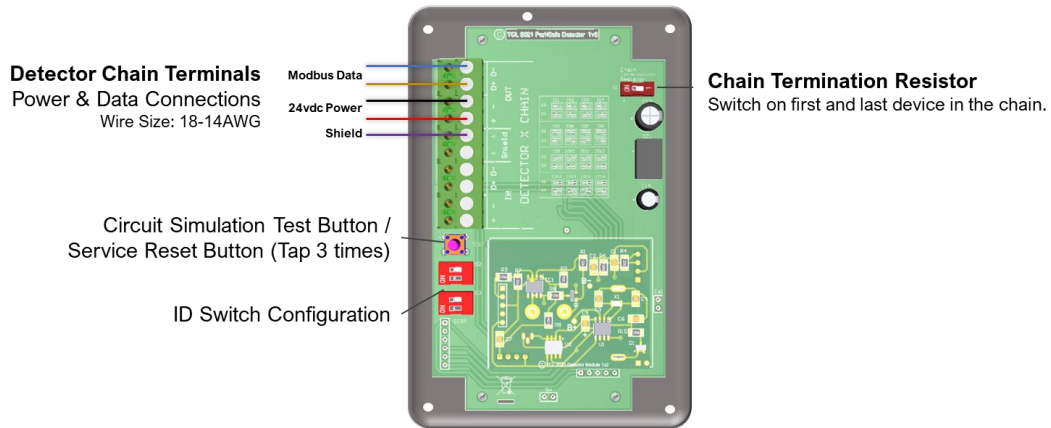

Wiring a ParkSafe Detector

- ⚠ If you are encountering noise or irregular problems with a Modbus link, the problem is likely related to grounding, incorrect shielding or wiring mains power next to Modbus wiring.
- ⚠ Reversing the [+] and [-] connections of any device can lead to the whole system to stop working owing to reverse polarity found on the terminals.
- ⚠ Detectors should be grounded to limit the effects of R/F & EMC interference by connecting shield wires to shield terminals!
- ⚠ Ensure the [120-ohm chain termination resistor] switch on at each end of a cable run to limit noise!
- ⚠ Detectors connect to either [IN] or [OUT] terminal sets!
- ⚠ Consider the 24vdc power voltage drop due to cable resistance when connecting multiple detectors over long distances!

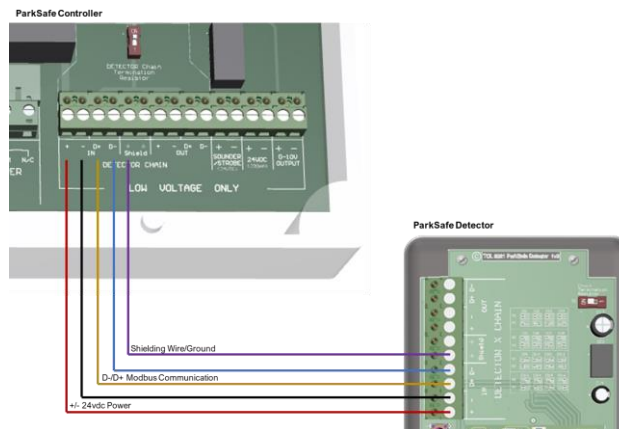

Power and Modbus data are wired between detectors with the first connected to a PARKSAFE controller [Detector Chain] terminal. If using a shielded wire (recommended) then connect the shield to [Shield Wire] dedicated terminals.

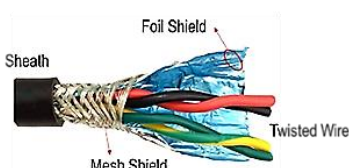

For Modbus communications, a shielded cable is used. The shielding can be of 2 types: braided [mesh of thin conducting wires] or foil (consisting of a thin sheet of metal covering the twisted wires). One example of such cable is BELDEN 3082A.

Wiring a ParkSafe Detector Chain

- ⚠ If you are encountering noise or irregular problems with a Modbus link, the problem is likely related to grounding, incorrect shielding or wiring mains power next to Modbus wiring.
- ⚠ Reversing the [D+] and [D-] connections of any device can lead to the whole system to stop working owing to reverse polarity found on the terminals.
- ⚠ Detectors should be grounded to limit the effects of R/F & EMC interference by connecting shield wires to shield terminals!
- ⚠ Detectors connect to either [IN] or [OUT] terminal sets!
- ⚠ Consider the 24vdc power voltage drop due to cable resistance when connecting multiple detectors over long distances!

Up to sixteen (16) PARKSAFE Detectors can be connected, chained in a parallel ‘daisy chain’ method up to approx. 545 yards from the controller depending on chain configuration, wire type and condition. Any other way may cause issues or damage to the overall system.

It is recommended that the cable of same color should be used to connect all [D+] terminals together and similarly cable of same color is used to connect all [D-] terminals together.

Single chain example

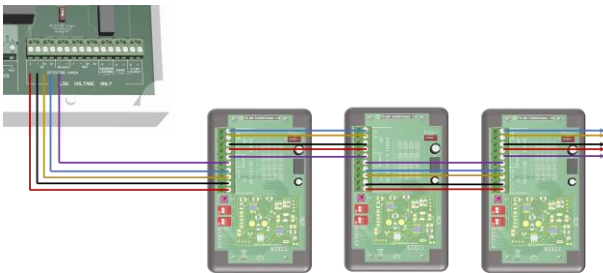

Split chain example

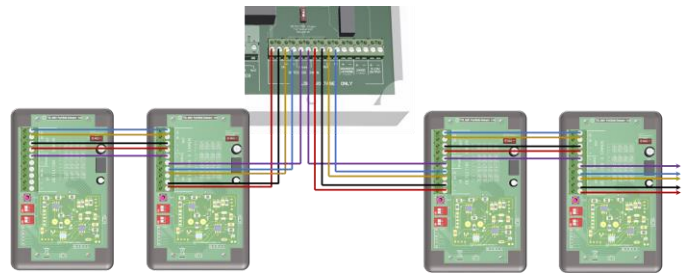

ParkSafe Detector ‘ID’ Switches

- ⚠ All PARKSAFE Detectors are factory set to ID 1!
- ⚠ We recommend a plan, map and/or marking the detector enclosures detailing ID and location!
- ⚠ ID Switches must be configured for each detector connected to receive and display accurate data!

When wiring multiple detectors, it is important to identify each detector installed for the controller to receive and display accurate data corresponding with the correct device. The ID configuration diagram is printed on the PARKSAFE Detector circuit boards for quick reference as shown opposite. All detectors are factory set to ID1.

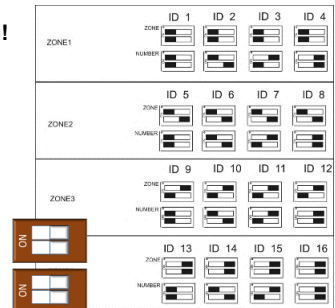

120ohm Termination Resistance

Signal communication issues may occur where the bus length is too long, high baud rates are used or signal reflections are occurring. To avoid this, terminating at each end of a detector chain may help the quality of the data signal by turning on the 120-ohm terminal resistor switch.

If a split chain is used, terminate the last detector in each chain.

If a single chain is used, terminate the first device (PARKSAFE Controller) and last device (PARKSAFE Detector).



Split chain

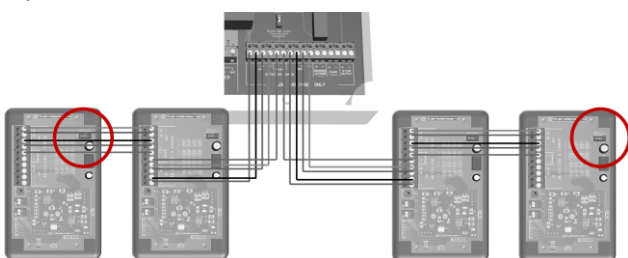

Single chain

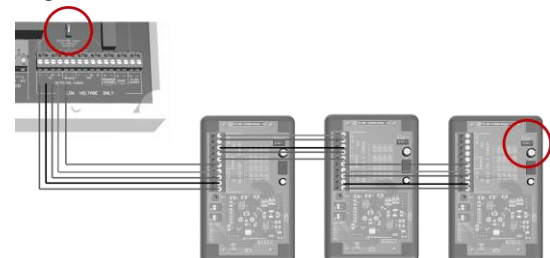

Manual Circuit Test

- ⚠ Access to the interior of the detector, when carrying out any work, must be conducted by a competent person!
- ⚠ This circuit test does not check the gas sensing element itself!

When the test button on the detector board is pressed and held – the detector will simulate an open circuit to ensure all configured systems, outputs, alarms, indications, and other external devices operate as intended in response to gas. When the test button is released – the test sequence will terminate and return to normal operation.

Operation

First Power Up

- ⚠ We recommend all gas detection systems be commissioned by a competent/trained engineer to ensure correct installation and operation!



1. On connecting power, your gas detector Power LED will illuminate.
2. The gas detector then enters a stabilisation phase for approximately 60 seconds – during this time the Fault LED will flash indicating that the device is not yet ready for operation.
3. The gas detector will then establish a Modbus data signal with the PARKSAFE Controller – during this time the Fault LED will remain lit.
4. When the data signal has established with the PARKSAFE Controller, the Fault LED will switch off and the detector will be in operation. Check your PARKSAFE Controller for the gas detector status.

LED Indications

- **Power**
The Power LED will remain illuminated when power to the detector is present.
- **Fault**
An issue with the gas sensing module, i.e. it has been removed/not installed properly or
The gas sensing module has reached the end of its expected lifecycle or
The gas detector annual service.
- **Alarm**
The system is in alarm condition because dangerous gas levels detected.

Gas Detector Alarm Set Points

▲ Rising alarm
PPM (Parts per Million)

Detector Type	Pre-Alarm	Alarm
Carbon Monoxide (CO)	▲ 25ppm	▲ 100ppm
Nitrogen Dioxide (NO2)	▲ 0.7ppm	▲ 2.0ppm

Maintenance

Cleaning

-  Concentrations of alcohol found in many products may damage, deteriorate or affect the gas sensing elements such as; wine; deodorants; stain removers and thinners. Other gases and substances to avoid are; corrosives (i.e. chlorine & hydrogen chloride); alkali metals; basic or acidic compounds; silicones; tetraethyl lead; halogens and halogenated compounds!

Keep your PARKSAFE Controller and Detectors in good working order

- Remove any dust/debris from the outer enclosures regularly using a slightly damp cloth.
- Never use detergents or solvents to clean your device(s).
- Never spray air fresheners, hair spray, paint or other aerosols near the detectors.
- Never paint the device(s). Paint will seal vents and interfere with the equipment.

Manual Circuit Simulation Test

-  Access to the interior of the detector, when carrying out any work, must be conducted by a competent person!
-  This circuit test does not check the gas sensing element itself!

When the test button on the PARKSAFE Detector circuit board is pressed and held, it will simulate an open circuit to ensure all configured systems, outputs, alarms, indications and other external devices operate as intended in response to dangerous levels of gas. When the button is released – the test sequence will terminate and return to normal operation.

Annual Service Message





-  The annual service message timer will begin after five (5) hours of continuous power irrespective of whether the system is then used intermittently!



EOL or SERVICE REQUIRED

A service message will appear on the PARKSAFE controller home screen after one year of any connected PARKSAFE Detector operation. The detector will still operate during this time, but you should contact your supplier immediately. We recommend that the system is serviced/bump tested at least annually from the date of installation for optimum performance and protection due to sensitivity drifts. Enter the status screens on the controller to determine if the PARKSAFE Detector requires a [Service] or if it has reached its [End of Life].

End of Operational Life (EOL)

-  The EOL is approximate from the first five (5) hours of continuous power!
-  The EOL will depend on the type of gas your detector is targeting and may vary depending on its application and environmental conditions such as the frequency of exposure to the target gas, poisons or inhibitors!
-  At the end of their working life, electrochemical sensors for PARKSAFE detectors should be disposed of in an environmentally safe manner. Alternatively, all detectors can be securely packaged and returned to AGS clearly marked for disposal.
-  Electrochemical sensors should not be incinerated as this may cause the cell to emit toxic fumes.



EOL or SERVICE REQUIRED

Enter the status screens on the controller to determine if the PARKSAFE Detector requires a [Service] or if it has reached its [End of Life]. End of Life means the detector will need replacing and the Detector 'Fault' LED will remain illuminated. The typical life of a PARKSAFE Detector depends on its application, environment and intended target gas. In addition, the operational life may be prolonged if the equipment is installed and maintained in accordance the instructions stated within this manual.

Bump Testing (Gas Response Check)

⚠ All certified test gases supplied by AGS are classified as non-flammable and non-toxic, however, they may contain gas under pressure and may explode if heated to extreme temperatures and cause asphyxiation in high concentrations. Always use in accordance with the safety data sheet!

Gas response checks are often referred to as a 'bump test'. Bump tests are important to make sure a device is able to detect a release of gas as early as possible. The aim of the bump test is to make sure a detector is working at its optimum by briefly exposing the unit to a known concentration of the target gas that usually exceeds the highest alarm point. If the detector goes into alarm and all signals/outputs activate, then the system is working safely.

If the system fails to operate as intended in an alarm state, the gas detector must not be used until a full inspection and service has been conducted. NFPA requires all gas detectors to be tested annually and that the test results be recorded on site and available to inspectors.

A detector may visually appear in good working order, but its sensitivity and accuracy can be inhibited by external factors. Dust, humidity, temperature fluctuations, cleaning products, contaminants, exposure to its target gas or sensor drift (ageing) can cause a decline in sensitivity, accuracy and eventual failure.

Regular bump tests are important to make sure the detector is able to detect a release of gas as early as possible and usually takes seconds (gas type dependant i.e. CO sensors will take over a minute) and is often completed alongside a scheduled fire alarm test, however the frequency should be determined following an appropriate risk assessment by the end user.

We recommend testing detectors every 12-18 months along with the regular fire test procedures and coincide with the annual service message prompted on the detection system after each year of service/operation.

Contact your AGS representative for details of suitable bump testing kits and gases. Kits usually consist of a certified gas cylinder or spray. We recommend only using AGS calibration gas kits to ensure correct flow rates meet AGS technical requirements. A bump testing gas is usually a concentration mix that exceeds the highest alarm set point.

Standard Test Gases

⚠ All certified test gases supplied by AGS are classified as non-flammable and non-toxic, however, they do contain gas under pressure and may explode if heated to extreme temperatures and cause asphyxiation in high concentrations.

See below for recommended gas concentrations for bump testing your detector.

Detector Type	Standard Test Gas	Response Time t90
CO - Carbon Monoxide	>100ppm (balance in air).	<60s
NO2- Nitrogen Dioxide	>2.0ppm (balance in air)	<60s

Bump Test Procedure

- ⚠ Step 1 will enable service mode and inhibit all alarms/outputs and signals for fifteen (15) minutes!**
- ⚠ If you are testing all actuation of alarms/outputs and signals please proceed to Step 2!**
- ⚠ The controller will return to a normal operational state after fifteen minutes automatically unless service mode is disabled manually by pressing the [Exit] button on screen!**
- ⚠ Always remove the regulator/valve after use - All cylinders will re-seal upon removal of the regulator!**
- ⚠ Never use expired or 'near empty' gas cylinders!**
- ⚠ Always give at least five (5) minutes between testing the same unit or until gas has fully dispersed!**
- ⚠ Always consider safety and use equipment in accordance with Safety Data Sheets!**
- ⚠ If Service mode is activated – reset the system after completing the bump tests!**
- ⚠ Pressing silence on the controller will silence the internal buzzer when in alarm!**

Step 1

Activate Controller Service Mode

- ⚠ This will inhibit all alarms/outputs and signals for fifteen (15) minutes!
- ⚠ If you are testing all actuation of alarms/outputs and signals - proceed to Step 2!

- Access service mode by pressing the AGS logo on the controller (home screen logo only).
- The screen will display a service message prompt.
- Press Yes. (Note: All alarm signals/outputs will be inhibited for fifteen (15) minutes.
- Proceed to test gas detectors.
- Upon completion – exit service mode by pressing the ‘Exit’ button on screen.



Step 2.

Test Detector

- ⚠ Access to the interior of the detector, when carrying out any work, must be conducted by a competent person!

- Ensure you have the correct calibration gas for the device type.
- If using a cylinder - screw the regulator/valve into the gas cylinder outlet.
- Offer up the applicator hose/cone and fully cover the sensing element on the front case.
- Open the valve/regulator to allow the gas to be delivered at a pre-set flow rate.
- Apply gas to the gas inlet holes on the front of the detector housing.
- The PARKSAFE detector ‘Alarm’ LED will illuminate at the alarm set point.
- The PARKSAFE Controller will activate all configured outputs/relays (unless service mode is activated) and will display the gas concentration detected.
- Remove applicator hose/ cone and turn the gas cylinder regulator/valve off.
- Wait for detector to stabilise / return to normal.
- Reset the service reminder by tapping the circuit test button 3 times (within 2 seconds)
- Test complete.
- Record your test details.



End.

Technical Specification

General							
Model:	PARKSAFE Detector						
Gases:	Nitrogen Dioxide or Carbon Dioxide						
Size: (H x W x D)	4.92 x 3.15 x 1.38"						
Housing Material:	ABS						
Mounting:	Wall Mounting – No limits - Non-Hazardous Areas						
Weight:	1.6oz						
User Interface							
Display:	LED						
Visual Indicators:	Power / Alarm / Fault						
Audible Alarm:	None						
Power Supply							
Power Consumption:	15mA Max @ 24Vdc						
DC Power:	12-32Vdc (24vdc Nominal)						
Internal Fuse:	N/A						
Equipment							
Pollution Degree:	2						
Equipment Class:	2						
Environmental							
Ingress Protection:	Not Formally Evaluated						
Operating:	-10 ~ 50°C / 14 ~ 122°F 30 ~ 80% RH (non-condensing)						
Storage:	-25 ~ 50°C / -13~122F° up to 95% RH (non-condensing)						
Altitude Rating:	2000m						
Wiring							
Typical	Copper 18AWG (0.75mm ²) Min. 8x screw terminals.						
Other							
Communication	RS485 MODBUS RTU						
Sensor Specification							
Factory Calibration Conditions	25° ± 5°C - 77° ± 41°F (40-70% RH)						
Sensor Type	Electromechanical						
Gas Sensor	Measuring Range (ppm)	Calibration Gas	Response (T90)	Recovery (T10)	Alarm: 1 (Pre alarm warning)	Alarm: 2	*EOL (Years)
Carbon Monoxide (CO)	0-1000ppm	120ppm CO	<60s	<50s	▲25ppm	▲100ppm	5
Nitrogen Dioxide (NO ₂)	0-20	5ppm NO ₂	<60s	<50s	▲0.7ppm	▲2ppm	3

▲ Rising Alarm ▼ Falling alarm *EOL – Expected operational Life – Replace unit after this time.

Every effort is made to ensure the accuracy of this document; however, AGS can assume no responsibility for any errors or omissions in this document or their consequences. AGS would greatly appreciate being informed of any errors or omissions that may be found in the content of this document. For information not covered in this document, or if there is a requirement to send comments/corrections, please contact AGS using the contact details.

Find out more

American Gas Safety LLC

www.americangassafety.com

Head office:

6304 Benjamin Road, Suite 502, Tampa, FL 33634

Tel: (727) 608-4375

Email: info@americangassafety.com



American Gas Safety LLC is the owner of this document and reserves all rights of modification without prior notice.