



## Merlin FS1

### Single Fan Switch



## User Guide



Please read this guide carefully and retain for future use.

The FS1 is designed to work together with the Merlin range of utility systems to add extra functionality and provide simplicity to the user. The FS1 is a microcontroller based single fan switch to automatically switch a fan on and off.











The information contained within this manual should be referenced for typical installation and operation only. For specific requirements that may deviate from the information in this guide – contact your supplier.

## Contents

<b>IMPORTANT SAFETY WARNINGS .....</b>	<b>3</b>
General Information.....	4
Mounting .....	4
Power Supply .....	4
Fan Connections.....	4
System On & Off.....	4
LED Status (Fan On) .....	4
Manual Override .....	5
How to Select Power-Down Delay in Automatic Mode .....	5
FS1 Wiring Diagram .....	5
<b>General Specification .....</b>	<b>6</b>

# IMPORTANT SAFETY WARNINGS

-  Before any installation, use or maintenance read this manual carefully.
-  The information contained within this manual should be referenced for typical installation and operation only.
-  For site specific requirements that may deviate from the information in this guide – contact your supplier.
-  If this device is used in a manner not specified by the manufacturer, the safety provided by the device may be impaired.
-  This device is designed for indoor operation only.
-  The internal fuse should be replaced only with the same type. Anti-surge fuse 3.15A 250Vac 5x20.
-  It is recommended that this device be commissioned upon installation and serviced annually.
-  This device requires a continual supply of electrical power – it will not work without power.
-  Your product should reach you in perfect condition, if you suspect it is damaged, contact your supplier.

---

## Manufacturer's Warranty

Warranty Coverage: The manufacturer warrants to the original consumer purchaser, that this product will be free of defects in material and workmanship for a period of three (3) years from date of purchase.

The manufacturer's liability hereunder is limited to replacement of the product with repaired product at the discretion of the manufacturer. This warranty is void if the product has been damaged by accident, unreasonable use, neglect, tampering or other causes not arising from defects in material or workmanship.

This warranty extends to the original consumer purchaser of the product only.

Disclaimers: Any implied warranties arising out of this sale, including but not limited to the implied warranties of description, merchantability and intended operational purpose, are limited in duration to the above warranty period. In no event shall the manufacturer be liable for loss of use of this product or for any indirect, special, incidental or consequential damages, or costs, or expenses incurred by the consumer or any other user of this product, whether due to a breach of contract, negligence, strict liability in tort or otherwise. The manufacturer shall have no liability for any personal injury, property damage or any special, incidental, contingent or consequential damage of any kind resulting from gas leakage, fire or explosion. This warranty does not affect your statutory rights.

Performance: During the above warranty period, your product will be replaced with a comparable product if the defective product is returned together with proof of purchase date. The replacement product will be in warranty for the remainder of the original warranty period or for six months – whichever is the greatest.



### Information on waste disposal for consumers of electrical & electronic equipment.

When this product has reached the end of its life it must be treated as Waste Electrical & Electronics Equipment (WEEE).

Any WEEE marked products must not be mixed with general household waste, but kept separate for the treatment, recovery and recycling of the materials used. Please contact your supplier or local authority for details of recycling schemes in your area.

## General Information

The FS1 is a microcontroller based single fan switch to automatically switch a fan on and off.

The panel also features a selectable power off delay to allow residual fumes to dissipate and a manual override. The FS1 has been designed to work together with the Merlin range of utility systems to add extra functionality and provide simplicity to the user.

It is recommended that the user reads this guide before using the system. Please do NOT attempt to operate the unit until the contents of this document have been read and are thoroughly understood.

---

## Mounting

The control panel is designed for surface mounting using four mounting screws.

A flush mount kit is available (sold separately). Contact your supplier.

---

## Power Supply

The FS1 should be connected to the Merlin panel using low voltage cable [terminals marked 1 2 3]. - See wiring diagram

---

## Fan Connections

A single fan should be connected to the [OUT1] terminal block [L1,N and E]. Dry contact outputs are available for fan speed controllers.

See wiring – Section 3.

---

## System On & Off

When the Merlin utility panel is turned on, the FS1 will power the fan automatically when panel is in error condition and the [FAN ON] indicator will illuminate.

When error condition is cleared, the FS1 will turn the fans off instantly or at a pre-selected time delay (purge). The [FAN ON] indicator will flash.

To cancel purge mode, the manual override switch has to be turned on and off again.

---

## LED Status (Fan On)

(RED) – Power to fan enabled

(FLASHING) – Purge mode

(NO LED) – Power to fan disabled

---

## Manual Override

The ON and OFF switch mounted on the fascia of the FS1 panel can be used to manually turn the fan ON and OFF without using the associated Merlin utility controller.

There is no-power down time delay in the manual override mode.

## How to Select Power-Down Delay in Automatic Mode

S1	S2	MIN	Status
OFF	OFF	60	Power to the fans will be removed 60 minutes after the Merlin utility controller is turned off or in fault condition.
ON	OFF	40	Power to the fans will be removed 40 minutes after the Merlin utility controller is turned off or in fault condition.
OFF	ON	20	Power to the fans will be removed 20 minutes after the Merlin utility controller is turned off or in fault condition.
ON	ON	0	No delay. Power to the fans will be removed instantly when the Merlin utility controller is turned off or in fault condition.

## FS1 Wiring Diagram

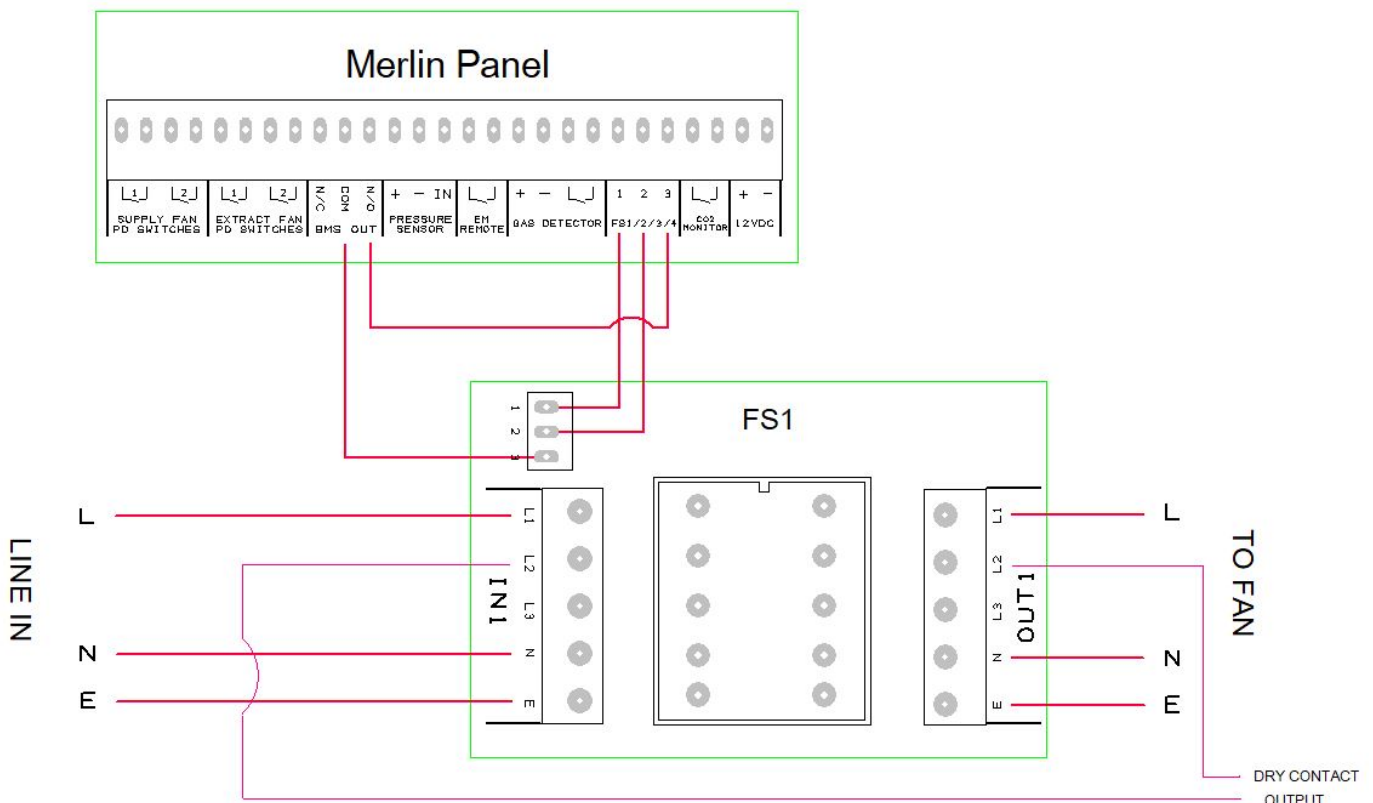

**BMS Selection DIP switch on Merlin utility panel has to be set to ON position!**

## General Specification

Model	FS1
Power Supply	12VDC from Merlin panel.
Current consumption	50mA @ 12V without load
Power consumption	0.6W without load
Maximum fan rating	(110V) 12A
Dry contact output	(110V) 12A Max
Operating temp. range	32 - 122°F
Body size	W 7.48" x H 5.51" x D 2.36"
Net Weight	28.2oz (0.8 kg)

Page intentionally left blank

Page intentionally left blank

**American Gas Safety LLC**

Head office:

6304 Benjamin Road, Suite 502, Tampa, FL 33634

Tel: (727) 608-4375

[info@americangassafety.com](mailto:info@americangassafety.com)



American Gas Safety LLC is the owner of this document and reserves all rights of modification without prior notice.