

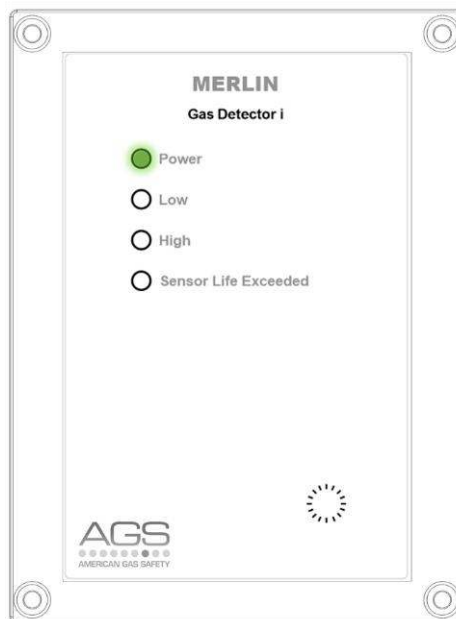

Merlin Gas Detector i

Carbon Monoxide (CO)



Safe Area Safety Monitoring - General Gas Detection



Installation, Operation & Maintenance

Please read this manual carefully and retain for future use.

For specific requirements that may deviate from the information in this guide – contact your supplier.

American Gas Safety LLC

www.americangassafety.com

Contents

Important Warning Statements	3
Installation	4
Typical Application & Location	4
Mounting & Cabling	5
Circuit Board Overview	6
Wiring: Power Input.....	6
Wiring: Alarm Relays.....	7
Alarm Relay Setting Switch – Latch On/Off.....	7
Wiring: 0-10V Analogue Output	7
Audible Buzzer Switch.....	7
Factory Set Condition.....	7
Operation	8
Initial Power Up.....	8
Latched Relay Alarm & Reset.....	8
Alarm Set Points.....	8
Maintenance	9
Cleaning	9
Manual Circuit Simulation Test	9
Bump Test (Gas Response Check)	9
Bump Test Procedure	10
End of Operational Life (EOL)	10
Specification	11

Important Warning Statements



Warning Symbol!

Where this symbol is used, the manual must be consulted to understand the nature of any potential hazards and how to avoid them.

- ⚠ Please take the time to thoroughly read these instructions which should be retained for future reference.
- ⚠ Detectors are shipped pre-calibrated and configured.
- ⚠ The expected lifetime of a gas sensor is 5 years upon initial power up dependant on your target gas and environmental factors. The device will indicate this time and should immediately be replaced.
- ⚠ It is recommended that this device be commissioned upon installation and serviced annually by a competent person.
- ⚠ Do not apply lighter gas or other aerosols to the device – this may cause extreme damage to the sensors.
- ⚠ High concentrations of alcohol found in many products may damage, deteriorate, or affect the gas sensing elements.
- ⚠ This product is not designed to detect smoke, fire or other gases and should not be used as such.
- ⚠ This device provides early warning of the presence of gas, usually before a healthy adult would experience symptoms. This warning is possible provided your alarm is installed and maintained in accordance with this manual.
- ⚠ Never ignore your device when in alarm.
- ⚠ This device requires a continual supply of electrical power – it will not work without power.
- ⚠ This device should not be used to substitute proper installation, use and/or maintenance of fuel burning appliances including appropriate ventilation and exhaust systems.
- ⚠ Multiple detectors may be required to adequately protect property and persons.
- ⚠ This device does not prevent dangerous gasses from occurring or accumulating.
- ⚠ The device is not intended for use in potentially explosive atmospheres.
- ⚠ Seek fresh air supply and contact your local gas emergency service should you suspect a gas leak.
- ⚠ This unit may not fully safeguard individuals with specific medical conditions. If in doubt, consult a doctor/physician.
- ⚠ Your product should reach you in perfect condition, if you suspect it is damaged, contact your supplier.
- ⚠ Concentrations of alcohol found in many products may damage, deteriorate or affect the gas sensing elements such as wine; deodorants; stain removers and thinners. Other gases and substances to avoid are corrosives (i.e., chlorine & hydrogen chloride); alkali metals; basic or acidic compounds; silicones; tetraethyl lead; halogens and halogenated compounds!

Manufacturer's Warranty

Warranty coverage: The manufacturer warrants to the original consumer purchaser, that this product will be free of defects in material and workmanship for a period of three (3) years from date of purchase.

The manufacturer's liability hereunder is limited to replacement of the product with repaired product at the discretion of the manufacturer. This warranty is void if the product has been damaged by accident, unreasonable use, neglect, tampering or other causes not arising from defects in material or workmanship. This warranty extends to the original consumer purchaser of the product only. **Warranty disclaimers:** Any implied warranties arising out of this sale, including but not limited to the implied warranties of description, merchantability and intended operational purpose, are limited in duration to the above warranty period. In no event shall the manufacturer be liable for loss of use of this product or for any indirect, special, incidental, or consequential damages, or costs, or expenses incurred by the consumer or any other user of this product, whether due to a breach of contract, negligence, strict liability in tort or otherwise. The manufacturer shall have no liability for any personal injury, property damage or any special, incidental, contingent or consequential damage of any kind resulting from gas leakage, fire, or explosion. This warranty does not affect your statutory rights. **Warranty Performance:** During the above warranty period, your product will be replaced with a comparable product if the defective product is returned together with proof of purchase date. The replacement product will be in warranty for the remainder of the original warranty period or for six months – whichever is the greatest.

Information on waste disposal for consumers of electrical & electronic equipment.

When this product has reached the end of its life it must be treated as Waste Electrical & Electronics Equipment (WEEE). Any WEEE marked products must not be mixed with general household waste, but kept separate for the treatment, recovery and recycling of the materials used. Please contact your supplier or local authority for details of recycling schemes in your area.



At the end of their working life, electrochemical sensors should be disposed of in an environmentally safe manner. Alternatively, they can be securely packaged and returned to AGS clearly marked for disposal. Electrochemical sensors should not be incinerated as this may cause the cell to emit toxic fumes.

Installation

Typical Application & Location

- ⚠ **Installation must be carried out by a licenced, insured contractor!**
- ⚠ **Ensure that detectors are not exposed to liquid or dust contamination!**
- ⚠ **Detectors and cables must be protected against mechanical damage!**
- ⚠ **Avoid conditions of any other environmental factors outside of the specification that could potentially impede the accuracy and operation of the detector such as condensation; vibration; temperature, pressure, the presence of other gases, electromagnetic interference, and draft zones!**
- ⚠ **The target gas will only be identified when contact is made with the sensing element itself!**

Gas detectors should be installed in areas at risk of gas leaks e.g., near boilers, valves, or meters, located in positions determined by those who have knowledge of gas dispersion, the process plant system and equipment involved, and in consultation with both safety and electrical engineering personnel.

Take in to account the design of the air flow patterns within the area. Detectors should be installed in the correct orientation, as recommended, and ease of access should be accounted for to allow for any bump tests and other forms of maintenance throughout its operating life.

There are no official figures of the area coverage of a gas detector; however, 50m² per detector is a reasonable general guide therefore multiple detectors may be required to adequately protect property and persons. There are no specific standards governing gas detector location (unlike fire detection systems); there are, however, general guidance documents. The most relevant being *IEC 60079-29-2: Explosive Atmospheres – Part 29: Gas detectors – Selection, installation, use and maintenance of detectors for flammable gases and oxygen*. Much of what it covers is also relevant to toxic gas detection.

Recommended heights may vary based on air flow and temperature conditions in addition to the proposed application and location. Locations for detectors will vary based on the intended application and target gas, they should be located near identified sources of a potential gas leaks/pockets where gas could quickly accumulate and areas of identified consequential risk to detect gas. The composition of the target gas and its density relative to air are used as the basis for the recommended height of sensors. Generally, the installation height of a sensor for a heavy gas (e.g., propane) would be close to the lowest point in the area, and for a light gas (such as methane) would be close to the highest point in the area. These typical positions may vary based on air flow and temperature conditions in addition to the proposed application and location – this is particularly apparent with oxygen depletion sensors, and the target gas that they are used for.

Target Gas	Typical Position
Carbon Monoxide (CO)	Breathing Zone - 1700mm (5ft 6”) from ground level

* If you are installing and monitoring oxygen depletion monitors – consider the density of gas for its application and position the detector accordingly i.e., ground level for high-density gases.

Detectors should be mounted where a potential hazard of gas is most likely to be present. The following points should be noted also when locating gas sensors. When locating detectors consider

- The possible damage caused by natural events e.g., rain or flooding.
- Ease of access to the gas detector for functional testing and servicing.
- How gas may behave due to natural or forced air currents.

Mounting & Cabling

- ⚠ If mounting direct to wall - ensure the wall surface is flat to prevent base distortion!
- ⚠ Ensure the rear base is installed in the correct orientation as shown!
- ⚠ Where cable glands/conduits are used for wire entry, use 20mm (3/4 inch) max separated by at least 20mm!
- ⚠ Any parts that form part of the connections/installation must have a minimum fire-retardant rating of UL94v-2!
- ⚠ Damage to PCBs when creating cable entry points or attempting to remove the circuit board may void any warranty!
- ⚠ The monitor is designed for either surface mounting or mounted on a one or two gang electrical box.
- ⚠ Restrain the hazardous live wiring from accidental loosening to prevent wires from moving after installation and touching parts of opposite polarity or at low voltages!
- ⚠ Isolate the equipment from all hazardous live power sources before opening the cover!

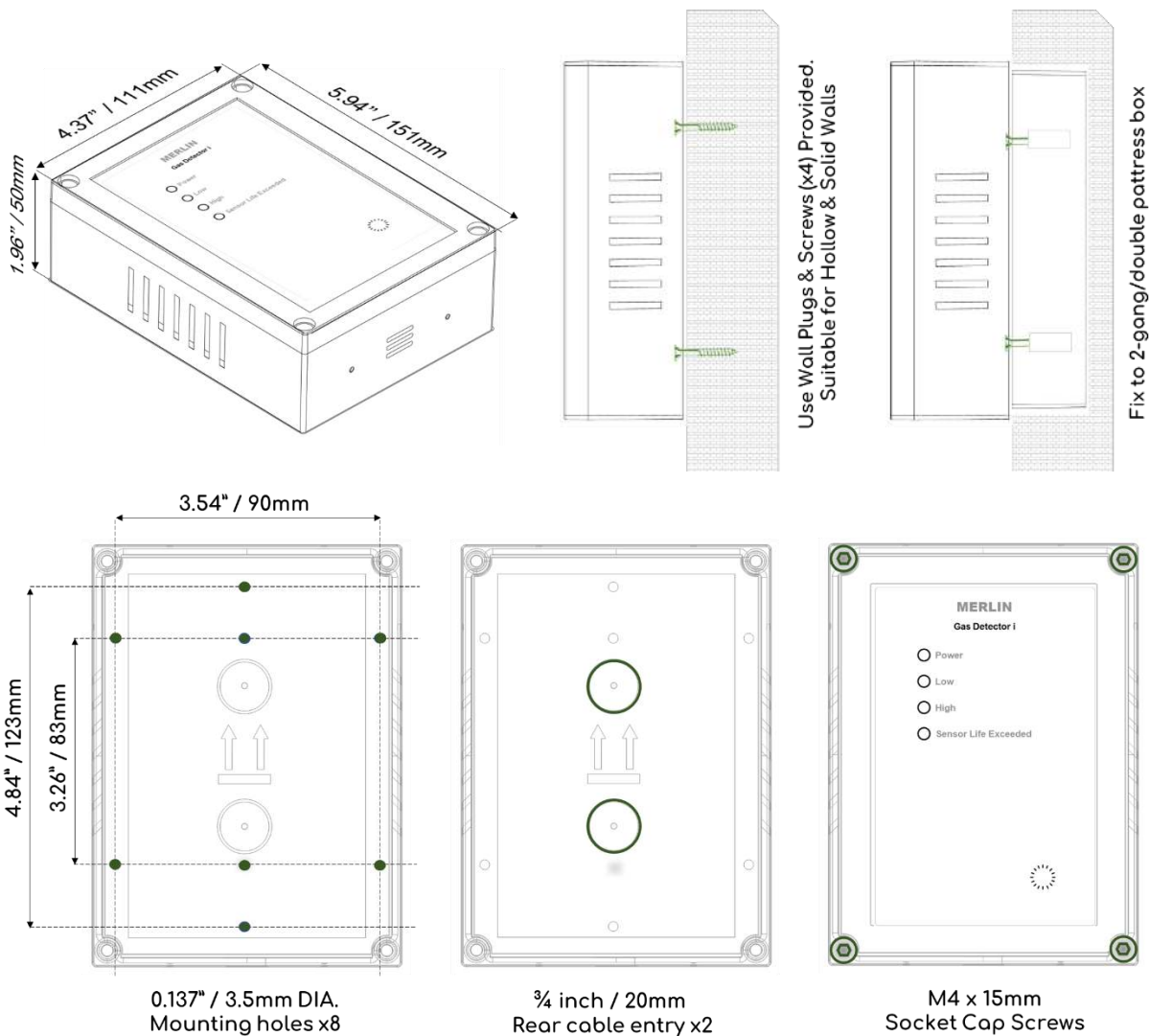

1. Carefully remove the front cover from the unit by using an M3 socket wrench.
2. Using the rear base - mark mounting holes to the wall or align with a vertical 2-gang/patress box.
3. Fixing straight to wall – drill 0.2" (5mm) hole, insert plugs and use the four screws (No.4 Pozzi) provided.
4. There are pre-fractured areas for cable entry on the rear of the base and pilot holes positioned on the top and bottom of the enclosure suitable for entry points up to 3/4" (20mm). Drill out as necessary ensuring all swarf is removed from the box and holes have smooth edges.
5. After executing the mounting/connections – secure the front cover with all M4 bolts and insert security caps provided.

Circuit Board Overview

- ⚠ **Damage to PCBs when creating cable entry points may void any warranty!**
- ⚠ **Any damage attempting to remove the circuit board may void any warranty!**
- ⚠ **A disconnecter is required and accessible for the 24V supply and an adequate overcurrent device is fitted!**

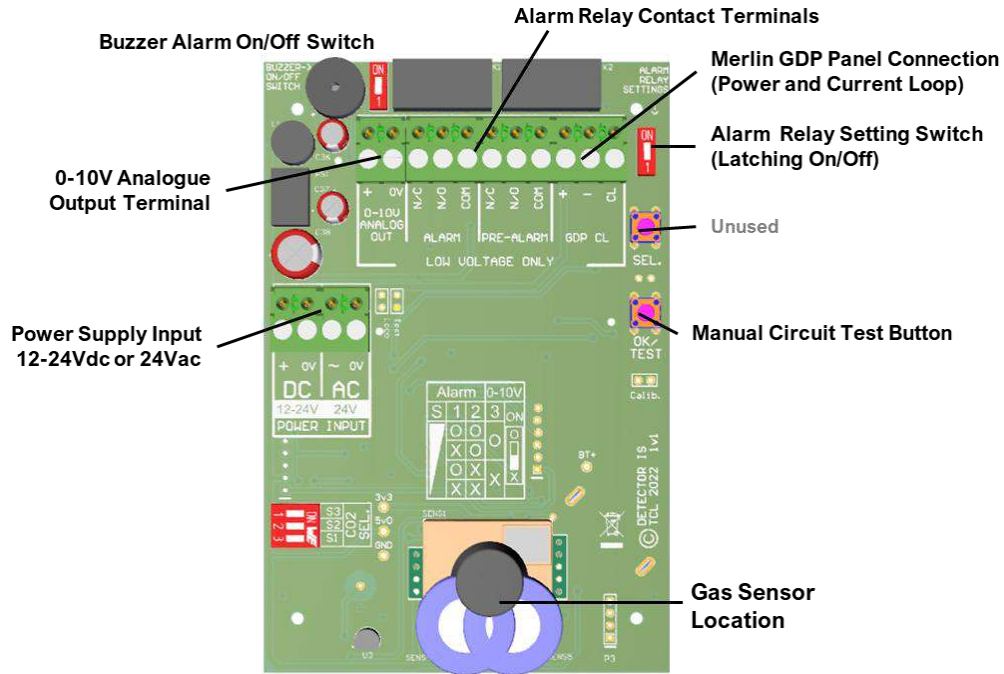

Wiring: Power Input

Standalone Power

Power can be provided either 24Vac or 12-24Vdc. Terminals are pluggable type to ease connections.

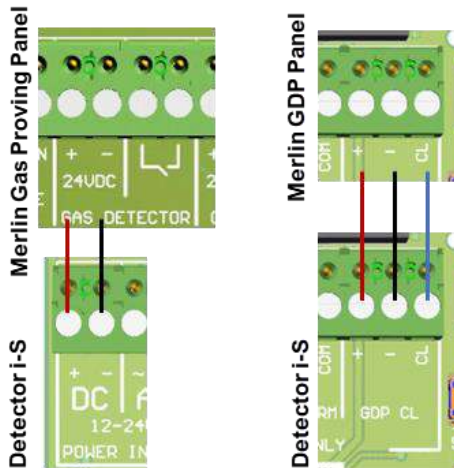
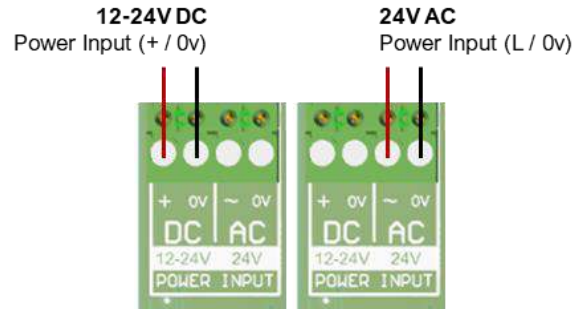

Merlin GDP Controller - Power Connection

Power is supplied via the GDP terminal [+ / -]. Use the [C/L] terminal as an alarm relay. Wire in parallel for multiple detectors.

Merlin Gas Proving Controller - Power Connection

Power is supplied via the 24VDC terminal [+ / -]. Use the open/close terminal as an alarm relay to detectors.

Wiring: Alarm Relays

These are dry contact connections to a BMS (building management systems) or Merlin panel to send an alarm signal upon pre/alarm levels of gas. Max 1A load @ 12/24Vdc or ac.

If you are connecting detector(s) via a GDP panel you will need to use the [C/L] terminal as an alarm relay. A relay will change state when in alarm or pre-alarm when gas is detected and if wired/configured to do so. These terminals can be used in conjunction with other external relays that affect other devices and controls such as purge fans and audible alarms etc.

Alarm Relay Setting Switch – Latch On/Off

 **The switch is left on as a factory set condition!**

This switch is used to latch/unlatch an alarm relay.

When turned on the detector relay will latch permanently on (until reset) in the event of the detector detecting gas and entering an alarm state.

The audible alarm will alert the user that the detector entered an alarm state. To reset the Detector, press and hold the touch button for ~3 seconds.

Wiring: 0-10V Analogue Output

This connection is used to regulate external fan speed controllers (supplied separately). Connect direct to fan speed controllers or via your Merlin panel [0-10V] terminal if available. 0-10V output is driven by the status of gas concentrations detected.

CO Alarm Type		0-10 Volt Output Range									
		1V	2V	3V	4V	5V	6V	7V	8V	9V	10V
CO - ET	PPM	30	60	90	120	150	180	210	240	270	300
CO - FL		n/a				20	n/a				35
CO - PK		n/a				25	n/a				100

Audible Buzzer Switch

There is a switch on the detector board identified as [Buzzer On/Off].

The detector can be configured to have an audible alarm or not when gas levels reach the main alarm set points. The alarm will continuously sound – there are no provisions to silence the alarm, gas levels must drop to a safe value for the alarm to stop.

Factory Set Condition

 **Detectors are shipped pre-calibrated and configured.**

Buzzer On/Off Switch	On
Alarm Relay Setting Switch	On

Operation

Initial Power Up

On connecting power, the Power LED will illuminate. The detector enters a warmup phase for approximately 60 seconds – during this time, Low, High & Sensor life Exceeded LEDs will flash until the unit is ready.

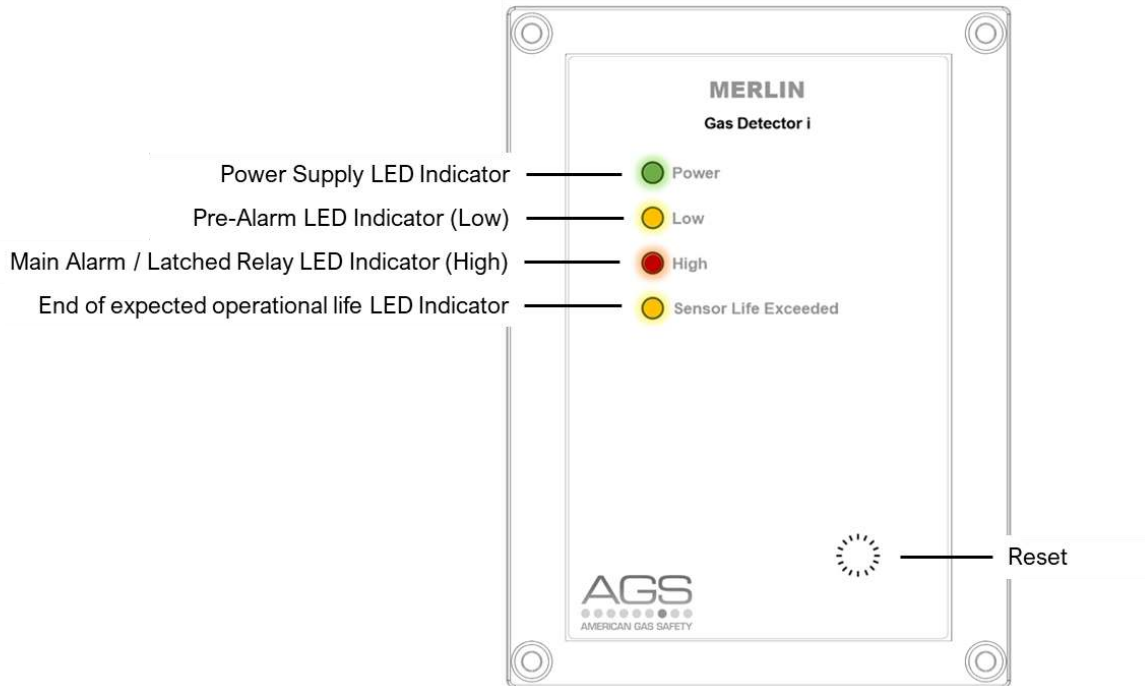

Latched Relay Alarm & Reset

If configured to latch upon alarm status (via dipswitch) the ‘High’ LED indicator will remain lit when the main alarm relay has latched.

The audible alarm will alert the user that the detector has entered a main alarm state (High).

To reset the detector, press and hold the touch sensor for ~3s.

Alarm Set Points

⚠ An audible buzzer will sound if the buzzer switch on the circuit board is on!

Alarm Type	LOW Pre-Alarm	Buzzer	HIGH Main Alarm	Buzzer
CO - ET	▲ 20ppm	None	▲ 20ppm after Two (2) Hours ▲ 50ppm after One (1) Hour ▲ 100ppm after Ten (10) Minutes ▲ 300ppm after One (1) Minute	Continuous sound
CO - FL	▲ 20ppm		▲ 35ppm	
CO - PK	▲ 25ppm		▲ 100ppm	

▲ Rising alarm ▼ Falling alarm (PPM) Parts Per Million

Maintenance



Cleaning

-  **Concentrations of alcohol found in many products may damage, deteriorate or affect the gas sensing elements such as; wine; deodorants; stain removers and thinners. Other gases and substances to avoid are corrosives (i.e., chlorine & hydrogen chloride); alkali metals; basic or acidic compounds; silicones; tetraethyl lead; halogens and halogenated compounds!**

Keep your gas detector in good working order - follow these basic principles.

- Remove any dust/debris from the outer enclosure regularly using a slightly damp cloth.
- Never use detergents or solvents to clean your device.
- Never spray air fresheners, hair spray, paint or other aerosols near the device.
- Never paint the device. Paint will seal vents and interfere with the device.

Manual Circuit Simulation Test

-  **Access to the interior of the detector, when carrying out any work, must be conducted by a competent person!**
-  **This circuit test does not check the gas-sensing element itself!**

When the test button on the circuit board is pressed and held for ~3seconds the detector will simulate an open circuit to ensure configured systems, outputs, alarms, indications, and other external devices operate as intended in response to gas.

The test sequence will automatically terminate after a short period of time and return to normal operation.

Bump Test (Gas Response Check)

What is a Bump Test?

Gas response checks are often referred to as a 'bump test'. Bump tests are important to make sure a device can detect a release of gas as early as possible. The aim of the bump test is to make sure a detector is working at its optimum by briefly exposing the unit to a known concentration of the target gas that usually exceeds the highest alarm point. If the detector goes into alarm and all signals/outputs activate, then the system is working safely.

If the system fails to operate as intended in an alarm state, the gas detector must not be used until a full inspection and service has been conducted.

Why is it important?

A detector may visually appear in good working order, but its sensitivity and accuracy can be inhibited by external factors. Dust, humidity, temperature fluctuations, cleaning products, contaminants, exposure to its target gas or sensor drift (ageing) can cause a decline in sensitivity, accuracy, and eventual failure.











How often?

Regular bump tests are important to make sure the detector can detect a release of gas as early as possible and usually takes seconds (gas type dependant i.e., CO sensors will take over a minute) and is often completed alongside a scheduled fire alarm test, however the frequency should be determined following an appropriate risk assessment by the end user. We recommend testing detectors every 12-18 months along with the regular fire test procedures and coincide with the annual service message prompted on the detection system after each year of service/operation.

What do I need?



Contact your AGS representative for details of suitable bump testing kits and gases. Kits usually consist of a certified gas cylinder or spray. We recommend only using AGS calibration gas kits to ensure correct flow rates meet AGS technical requirements. A bump testing gas is usually a concentration mix that exceeds the highest alarm set point.

Bump Test Procedure

-  **To increase reaction time, cover the escape vents at the sides of the device.**
-  **Always remove the regulator/valve if using a cylinder after use!**
-  **Always give at least five (5) minutes between testing the same unit or until gas has fully dispersed!**
-  **Always consider safety and use equipment in accordance with Safety Data Sheets!**
-  **Reference should always be given to any applicable national & local law and industry codes.**
-  **Generally, the gas concentration should be greater than the alarm threshold of the device.**
-  **Always remove the regulator/valve after use if using a cylinder!**
-  **All cylinders will re-seal upon removal of the regulator/valve!**
-  **Deviating from this test process is deemed improper and may affect the functional safety of your device!**
-  **Exposure to chemicals, smoke, or any other materials other than the gases intended to be monitored can seriously damage the gas sensing elements!**
-  **Always allow a minimum of 5 minutes before testing the same unit!**

1. Ensure you have the correct gas for the device type prior to application.
2. Offer up the applicator hose/cone or spray to the small vents of the device located underneath.
3. Apply gas.
4. The device will enter alarm status after reaching alarm set point.
5. The device will activate all configured outputs/relays.
6. Reset by pressing and holding the touch sensor for ~3s.
7. Test complete.
8. Record your test details.

End of Operational Life (EOL)

-  **The EOL is approximate from the first five (5) hours of continuous power!**
-  **The EOL will depend on the type of gas your detector is targeting and may vary depending on its application and environmental conditions such as the frequency of exposure to the target gas, poisons, or inhibitors!**

The typical life of a gas detector depends on its application and intended target gas, in addition the operational life can be prolonged if the system and equipment is installed and maintained in accordance the instructions stated within this manual. At the end of its predicted operational life – the detector will indicate the ‘Sensor Life Exceeded’ LED.

This indicates that the detector has reached its expected operational lifecycle, the detector may still respond to gas but you must contact your supplier immediately for replacement.

Specification

General								
Model:	Detector i							
Alarm Types:	CO-ET CO-FL CO-PK							
Target Gas:	Carbon Monoxide - CO							
Size: (H x W x D)	5.95 x 4.37 x 1.97" (151 x 111 x 50mm)							
Housing Material:	ABS PA765. Flame Retardant UL 94V-1							
Mounting:	Safe Zone - Indoor use - Wall Mounted							
Weight:	212g							
User Interface								
Display:	N/A							
Screen Brightness:	N/A							
Visual Indicators:	Power (Green) Low Alarm (Yellow) High Alarm (Red) EOL (Yellow)							
Audible Alarm:	>65dB @ 3.28ft (1m). Quiet conditions.							
Language:	English							
Power Supply								
Rated Power:	0.6W Max							
Rated Voltage:	12-24Vdc or 24Vac							
Relays								
Dry contact relay outputs:	1A switching current (resistive load) @ 24V AC/DC							
Environmental								
Ingress Protection (IP):	Not Formally Evaluated							
Operating:	-10 ~ 50°C / 20 ~ 90% RH (non-condensing)							
Storage:	0 ~ 50°C / 30 - 80% RH (no condensation)							
Altitude Rating:	2000m							
Wiring								
Typical	Min. 2.5mm ² / 75°C min / Tinned copper.							
Compliance								
Electrical Safety & EMC	CE / UKCA BS EN 61010-1:2010 +A1:2019. & BS EN 50270.							
Sensor Specification								
Alarm Type	Measuring Range	Steps	Response (t ₉₀)	Recovery (t ₁₀)	LOW (Pre-Alarm)	HIGH (Main Alarm)	*EOL (Years)	
Electrochemical								
CO-ET	0-300ppm	1	<60s	<60s	▲20ppm	▲ 20ppm after Two (2) Hours ▲ 50ppm after One (1) Hour ▲ 100ppm after Ten (10) Minutes ▲ 300ppm after One (1) Minute	5	
CO-FL					▲20ppm			▲35ppm
CO-PK					▲25ppm			▲100ppm

▲ Rising Alarm ▼ Falling alarm / *EOL – Expected Operational Life / PPM – Parts Per Million

Installation Details

Please pass this manual to the system owner / user.

Date of Installation:	
Installation Location:	
Organisation:	
Stamp/Signature of the installer:	

We recommend all Merlin gas detection equipment be commissioned by competent/trained engineers to ensure correct installation and operation. The Merlin range of gas detectors are calibrated when manufactured, however, we strongly recommend the detectors response and alarm signals are tested and validated once installed. This will ensure the equipment performs as intended and is free from any unforeseen damage caused by transit/installation.

Every effort is made to ensure the accuracy of this document; however, AGS can assume no responsibility for any errors or omissions in this document or their consequences. AGS would greatly appreciate being informed of any errors or omissions that may be found in the content of this document. For information not covered in this document, or if there is a requirement to send comments/corrections, please contact AGS using the contact details.

American Gas Safety LLC

www.americangassafety.com

Head office:

6304 Benjamin Road, Suite 502, Tampa, FL 33634

Tel: (727) 608-4375

Email: info@americangassafety.com



American Gas Safety LLC is the owner of this document and reserves all rights of modification without prior notice.