



ParkSafe Controller



Installation, Operation & Maintenance Manual

Please read this manual carefully and retain for future use.

For specific requirements that may deviate from the information in this guide – contact your supplier.

American Gas Safety LLC

www.americangassafety.com





















Content

Important Warning Statements	3
Installation	4
Typical Application & Location.....	4
ParkSafe Detector Placement Plan	5
Mounting & Cabling	5
Electrical Connections	6
Wiring AGS ParkSafe Detector(s).....	7
ParkSafe Detector 'ID' Switches	9
120ohm Termination Resistance.....	9
Access Configuration Settings.....	9
Configuration Settings Explained	10
Factory Set Condition	10
Operation.....	11
First Power Up	11
Alarm Indications	11
Temperature Indication	11
Silence & Reset Buttons	11
Gas Detection Status Information	12
Detector Status Meaning	12
ParkSafe Detector Alarm Set Points	12
Modbus Communication Rescan	12
Maintenance	13
Cleaning.....	13
Manual Circuit Simulation Test	13
Annual Service Message	13
End of Operational Life (EOL).....	13
Bump Testing (Gas Response Check).....	14
Bump Test Procedure	14
Test Record.....	16
Specification.....	18

Important Warning Statements



Where this symbol is used, the manual must be consulted to understand the nature of potential hazards and how to avoid them.

-  Ensure that this manual is read and understood before installing / operating / maintaining the equipment.
-  The information contained within this manual should be referenced for typical installation and operation only.
-  For site specific requirements that may deviate from the information in this guide – contact your supplier.
-  If the equipment is used in a manner not specified by the manufacturer, the safety/protection provided by the equipment may be impaired.
-  Isolate the equipment from all hazardous live power sources before opening the cover.
-  This device is designed for indoor operation only.
-  It is recommended that this device be commissioned upon installation and serviced annually.
-  This equipment is designed to detect carbon monoxide and nitrogen dioxide when PARKSAFE detectors are used. Sold separately.
-  It is NOT designed to detect smoke, fire or other hazards and should NOT be used as such.
-  This device provides early warning of the presence of nitrogen dioxide or carbon monoxide when PARKSAFE detectors are connected, usually before a healthy adult would experience symptoms.
-  This early warning is possible provided your alarm is located, installed, and maintained as described in this manual.
-  This device requires a continual supply of electrical power – it will not work without power.
-  This device should not be used to substitute proper installation, use and / or maintenance of fuel burning appliances including appropriate ventilation and exhaust systems.
-  This device does not prevent nitrogen dioxide or carbon monoxide from occurring or accumulating.
-  Actuation of your alarm indicates the presence of dangerous levels of NO₂ or CO.
-  Seek fresh air supply and contact your local gas emergency service should you suspect a gas leak.
-  This device may not fully safeguard individuals with specific medical conditions.
-  If in doubt, consult a doctor / physician.
-  Your product should reach you in perfect condition, if you suspect it is damaged, contact your supplier.
-  Concentrations of alcohol found in many products may damage, deteriorate, or affect the gas sensing elements such as wine; deodorants; stain removers and thinners. Other gases and substances to avoid are corrosives (i.e., chlorine & hydrogen chloride); alkali metals; basic or acidic compounds; silicones; tetraethyl lead; halogens and halogenated compounds!

Manufacturer's Warranty

Warranty coverage: The manufacturer warrants to the original consumer purchaser, that this product will be free of defects in material and workmanship for a period of three (3) years from date of purchase.

The manufacturer's liability hereunder is limited to replacement of the product with repaired product at the discretion of the manufacturer. This warranty is void if the product has been damaged by accident, unreasonable use, neglect, tampering or other causes not arising from defects in material or workmanship. This warranty extends to the original consumer purchaser of the product only. **Warranty disclaimers:** Any implied warranties arising out of this sale, including but not limited to the implied warranties of description, merchantability and intended operational purpose, are limited in duration to the above warranty period. In no event shall the manufacturer be liable for loss of use of this product or for any indirect, special, incidental, or consequential damages, or costs, or expenses incurred by the consumer or any other user of this product, whether due to a breach of contract, negligence, strict liability in tort or otherwise. The manufacturer shall have no liability for any personal injury, property damage or any special, incidental, contingent or consequential damage of any kind resulting from gas leakage, fire, or explosion. This warranty does not affect your statutory rights. **Warranty Performance:** During the above warranty period, your product will be replaced with a comparable product if the defective product is returned together with proof of purchase date. The replacement product will be in warranty for the remainder of the original warranty period or for six months – whichever is the greatest.

Information on waste disposal for consumers of electrical & electronic equipment.



When this product has reached the end of its life it must be treated as Waste Electrical & Electronics Equipment (WEEE). Any WEEE marked products must not be mixed with general household waste, but kept separate for the treatment, recovery and recycling of the materials used. Please contact your supplier or local authority for details of recycling schemes in your area.

At the end of their working life, electrochemical sensors should be disposed of in an environmentally safe manner. Alternatively, they can be securely packaged and returned to AGS clearly marked for disposal. Electrochemical sensors should not be incinerated as this may cause the cell to emit toxic fumes.

Installation

Typical Application & Location

- ⚠️ Refer to your PARKSAFE Detector manual for important information regarding coverage, location and positioning including areas and conditions to avoid!
- ⚠️ Installation must be in accordance with recognised standards in the country concerned, for North America, NEC / CEC regulations should be followed!
- ⚠️ Access to the interior of the controller, when carrying out any work, must only be conducted by trained personnel!
- ⚠️ Before carrying out any work ensure local regulations and site procedures are followed!
- ⚠️ The use of sound strobes is highly recommended!
- ⚠️ Consult with local codes for the specific requirements!

In parking structures, CO and NO2 are two of the most abundant airborne contaminants and poses significant safety concerns. The CO and NO2 levels must be controlled or ventilated when concentrations approach hazardous levels. The controller is designed for installation into car parking facilities and enclosed garages paired with AGS ParkSafe detectors (Nitrogen Dioxide and Carbon Monoxide) that will be linked via Modbus RTU protocol back to the controller and monitor the detectors in numbers up to 16 (per controller) and automatically control ventilation systems according to gas levels and an optional temperature level. The ParkSafe controller monitoring system can activate both the exhaust fan(s) and the air intake device(s) such as outside air louvers/dampers and make up air units

The ParkSafe will make or break a dry contact internally on relay terminals [Output-1] and a second contact on [Output-2]. This is to have a live feed to the ventilation system wired through the contact so that the ParkSafe can activate ventilation systems; this can be either via a direct live feed or via a run signal. Another output relay will energise after [Output-2] has been active for an extended period. This is used for a link to a BMS or other external indication device. The controller also has a 0-10vdc output to allow the controller to drive VFD's based on gas level outputs.

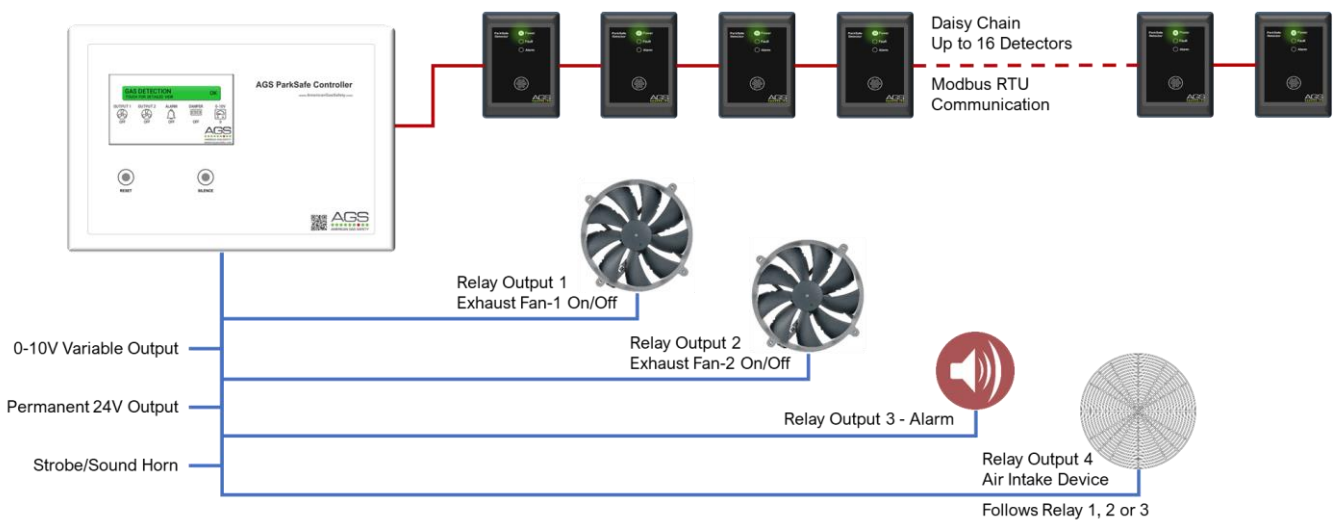

Addressable AGS ParkSafe detectors are daisy-chained through a RS485 RTU communication protocol to the controller. The controller must be located out of reach of the public, preferably located inside, close to the motor control centre or in connecting offices. Place the controller in accordance with applicable regulations.

Easy accessibility is recommended for both status observation and alarm purposes.

ParkSafe Detector Placement Plan

The relative density of carbon monoxide compared to air of carbon monoxide is 0.957 (AIR =1). The carbon monoxide will disperse evenly in the air. The carbon monoxide monitors must be located as specified by your region’s building code. If not specified contact your local AGS representative. Detection of nitrogen dioxide is done where a significant quantity of diesel engines is typically located such as train stations, bus and truck maintenance garages, rapid transit authorities, car dealerships, ambulance bays, loading docks and diesel-powered vehicle parking structures. ParkSafe detectors should be mounted where a potential hazard of gas is most likely to be present. The following points should be noted when locating gas sensors. When locating detectors consider

- **The possible damage caused by natural events e.g., Rain or flooding.**
- **Ease of access to the gas detector for functional testing and servicing.**
- **How gas may behave due to natural or forced air currents.**

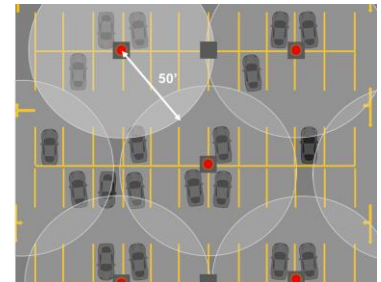

The quantity of sensors is determined by the following rules of thumb:

1. **The radius of coverage is approx. 15.2 m (50 feet) per Detector or 2,310 sq.m (7,580sq. ft).**
2. **Use open interior support columns as much as possible to maximize the radius of coverage.**
3. **Each level of the parking structure must be totally covered without overlapping the coverage of the sensors.**

Mounting & Cabling

- ⚠ **Where cable glands/conduits are used for wire entry, use no bigger than 20mm (3/4”) separated by at least 20mm (1/2”)! Any parts that form part of the connections/installation must have a minimum fire-retardant rating of UL 94 V-1!**
- ⚠ **Restrain the hazardous live wiring from accidental loosening to prevent wires from moving after installation and touching parts of opposite polarity or at low voltages!**
- ⚠ **Designed for surface mounting, it must be installed by a licensed, insured contractor!**

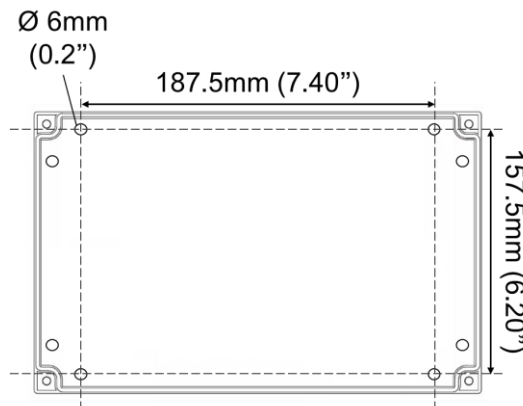

Carefully remove the front cover from the unit by unscrewing the four M6 hex bolts located at each corner. To do this – use the socket wrench provided.

Ensure the wall surface is solid and flat to prevent base distortion and mark the four 6mm (0.236”) screw holes located on the back of the enclosure to the wall.

Use a suitable screw/bolt (M4x30min) and appropriate expanding plug to fix the back of the enclosure to the wall surface. Drill out as necessary ensuring all swarf is removed from the box and holes have smooth edges.

After executing the mounting and the electrical connections – replace the front cover and insert the security caps over the four M6 hex bolts.

Electrical Connections

- ⚠ Access to the interior of the controller, when carrying out any work, must be conducted by a competent person!
- ⚠ Where cable glands are used for wire entry, use no bigger than 20mm (3/4") separated by at least 20mm (1/2")!
- ⚠ Any parts that form part of the enclosure - connections/installation must have a minimum fire-retardant rating of UL 94 V-1!
- ⚠ External wiring routed through the 'volt free' relays (Output 1 & 2, Alarm and Damper) require double insulated wiring for safety!
- ⚠ Be careful when creating access for cables – Damage to circuit boards will void any warranty!
- ⚠ Before carrying out any work ensure local regulations and site procedures are followed!
- ⚠ For Modbus communications, a shielded cable is used!
- ⚠ For field connections use wires suitable for at least 90°C (194°F)
- ⚠ Isolate the equipment from all hazardous live power sources before opening the cover!
- ⚠ A switch or circuit breaker must be included in the installation! It must be suitably located and easily reached to allow for disconnection of the equipment! It must be marked as the disconnecting device of the equipment!
- ⚠ If you are encountering noise or irregular problems with a Modbus link, the problem is likely related to grounding, incorrect shielding or wiring mains power next to Modbus wiring.

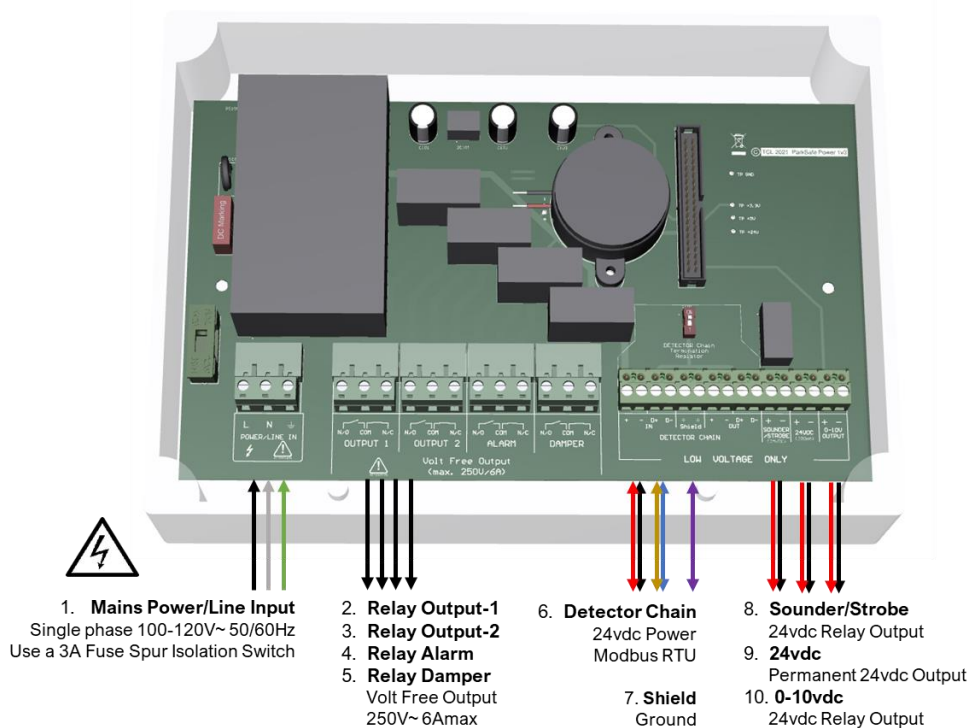

1. **POWER/ LINE IN.**
The ParkSafe controller requires a power supply of 100-120Vac using a 3A switched fused spur. When mains live power is connected to the controller, a red LED will illuminate on the front of the controller (AGS Logo).
2. **OUTPUT-1.**
Switches when a ParkSafe detector reaches 'pre-alarm' status. The [0-10v Output] will send 5v signal.
3. **OUTPUT-2.**
Switches when a ParkSafe detector reaches 'alarm' status. The [0-10v Output] will send a 10v signal.
4. **ALARM.**
Switches following the [OUTPUT 2] relay when a ParkSafe detector remains in alarm status.
A delay time of 5,10,15,20 or 25 minutes is selectable in the system configuration settings.
5. **DAMPER.**
Switches together with either [Output-1], [Output-2] or [Alarm] relays - selectable in the system settings.

6. **DETECTOR CHAIN.**
24Vdc power and Modbus data connections to ParkSafe detectors.
Up to sixteen (16) ParkSafe detectors wire in series (daisy chain) up to approx. 500 yards per cable run from the controller depending on chain configuration and wire type/condition.
7. **SHEILD.**
For Modbus communication, a shielded and twisted pair cable is used. The shielding can be of two types: braided [mesh of thin conducting wires] or foil (consisting of a thin sheet of metal covering the twisted wires). To ground detectors the shield connects to the dedicated [Shield] terminals.
8. **SOUNDER/ STROBE.**
This relay output (24vdc) is for external sounder alarms/ strobe lighting and will activate on alarm.
9. **24VDC.**
This is a permanent 24Vdc power output for external auxiliary devices. Max output: 200mA.
10. **0-10V OUTPUT.**
This output signal sends either zero or 2V under normal operating conditions – selectable in the settings menu. 5V signal when [OUTPUT 1] relay switches. 10V signal when [OUTPUT 2] relay switches.

Wiring AGS ParkSafe Detector(s)

- ⚠ If you are encountering noise or irregular problems with a Modbus link, the problem is likely related to grounding, incorrect shielding or wiring mains power next to Modbus wiring.
- ⚠ Reversing the [D+] and [D-] connections of any device can lead to the whole system to stop working owing to reverse polarity found on the terminals.
- ⚠ Detectors should be grounded to limit the effects of R/F & EMC interference by connecting shield wires to shield terminals!
- ⚠ Ensure the [120-ohm chain termination resistor] switch on at each end of a cable run to limit noise!
- ⚠ Detectors connect to either [IN] or [OUT] terminal sets!
- ⚠ Consider the 24vdc power voltage drop due to cable resistance when connecting multiple detectors over long distances!

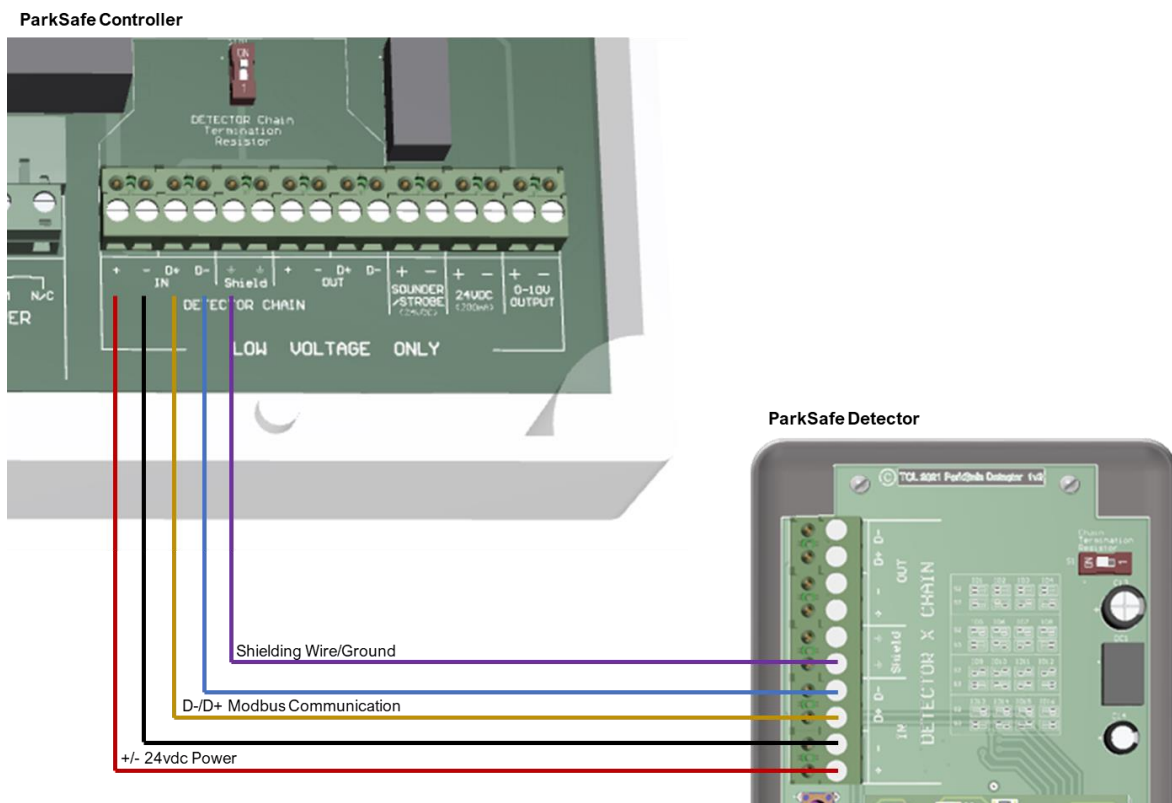

Power and Modbus data are wired between detectors with the first connected to a ParkSafe controller [Detector Chain] terminal. If using a shielded wire (recommended) then connect the shield to [Shield Wire] dedicated terminals.

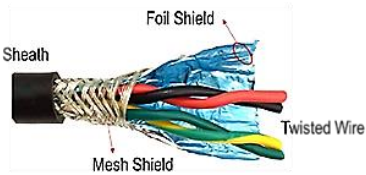

For Modbus communications, a shielded cable is used. The shielding can be of 2 types: braided [mesh of thin conducting wires] or foil (consisting of a thin sheet of metal covering the twisted wires). One example of such cable is BELDEN 3082A.

Up to sixteen (16) ParkSafe detectors can be connected, chained in a parallel ‘daisy chain’ method up to approx. 545 yards from the controller depending on chain configuration, wire type and condition. Any other way may cause issues or damage to the overall system.

It is recommended that the cable of same color should be used to connect all [D+] terminals together and similarly cable of same color is used to connect all [D-] terminals together.

Single chain example.

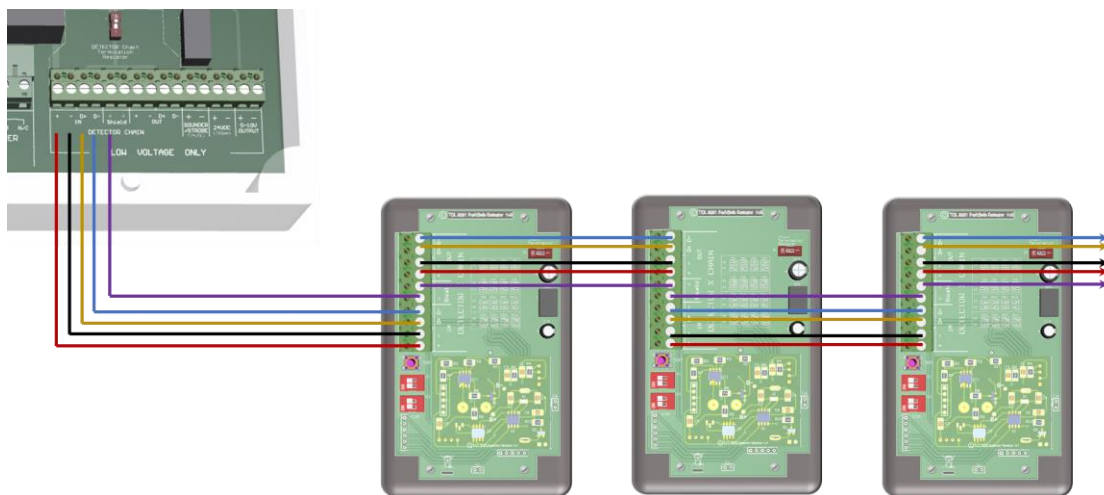

Split chain example

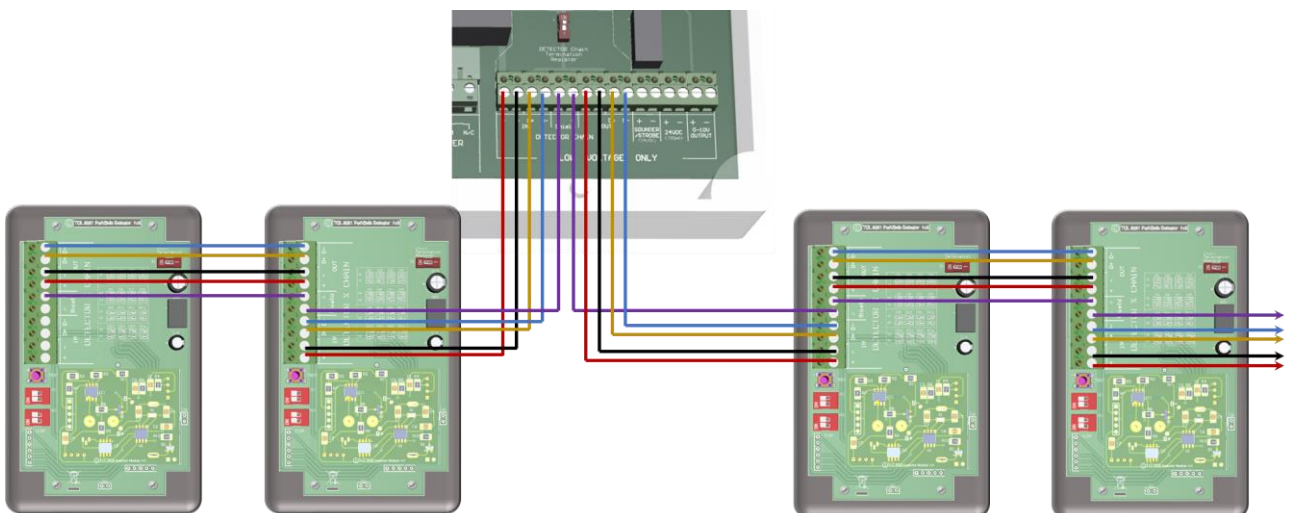

ParkSafe Detector 'ID' Switches

- ⚠ All detectors are factory set to ID 1!
- ⚠ We recommend a plan, map and/or marking the detector enclosures detailing ID and location!
- ⚠ ID Switches must be configured for each detector to receive and display accurate data!

When wiring multiple detectors, it is important to identify each detector installed for the controller to receive and display accurate data corresponding with the correct device. The ID configuration diagram is printed on the ParkSafe detector circuit boards for quick reference as shown opposite. All detectors are factory set to ID1.

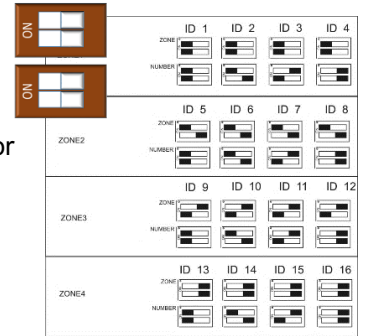

120ohm Termination Resistance

Signal communication issues may occur where the bus length is too long, high baud rates are used, or signal reflections are occurring. To avoid this, terminating at each end of a detector chain may help the quality of the data signal by turning on the 120-ohm terminal resistor switch.



If a split chain is used, terminate the last detector in each chain. If a single chain is used, terminate the first device (ParkSafe Controller) and last device (ParkSafe Detector).

Split chain

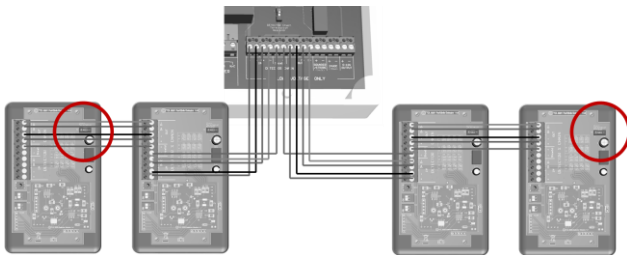

Single chain

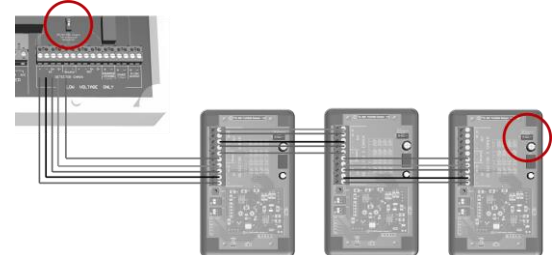

Access Configuration Settings

- ⚠ When changes are made – turn the settings switch off and the controller will automatically restart!
- ⚠ Access to the interior of the controller, when carrying out any work, must be conducted by a competent person!
- ⚠ Before carrying out any work ensure local regulations and site procedures are followed!

Turn on the [Settings] switch located on the display circuit board. The screen will display the settings menu. The ParkSafe controller has a touch screen, which allows the engineer/user to configure the system.

Adjust the screen brightness

(Press or slide the cursor up and down)

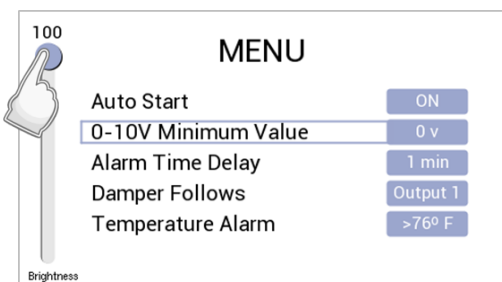

Change/select option

(Press the blue option box or press and hold)

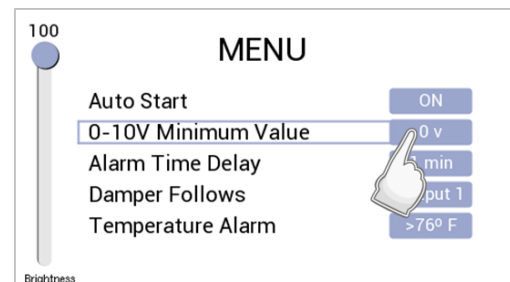

Configuration Settings Explained

FUNCTION	OPTION	Explanation
Auto Start	- ON - OFF	In the event of an unscheduled power loss/outage - the PARKSAFE controller will automatically restart when power is restored, or not.
0-10V Minimum Value	- 0 or 2V	0-10V terminal output under normal / safe conditions.
Alarm Time Delay	- 5 to 25	Time (minutes) for alarm relay to switch when detectors reach alarm status. (Following second relay Output 2). 5, 10, 15, 20 or 25minutes,
Damper Follows	- Output 1 - Output 2 - Alarm	The Damper relay output can switch together with either [Output-1], [Output-2] or the [Alarm] relays.
Temperature Alarm	- >68 to 86°F - Off	All Relays except Alarm will switch when the temperature exceeds the selected value. Select Off to disable function. Relays switch back when the temperature reaches 4°F below selected threshold.

Factory Set Condition

Auto Start	- ON	Controller will restart following an unscheduled power loss/outage.
0-10V Minimum Value	- 0V	No voltage output under normal condition status.
Alarm Time Delay	- 5	Following Output 2 relay switching, the Alarm relay will activate after five (5) minutes.
Damper Follows	- Output 1	Damper relay switches with [Output 1] relay.
Temperature Alarm	- Off	Temperature alarm disabled.

Operation

First Power Up

Upon connecting mains power, the ParkSafe controller will ‘warm up’ for approximately one minute. During this time, the screen will display an ‘initialising’ message. After the controller has initialised, the system will begin searching and establishing signals with any connected ParkSafe Detectors.

Alarm Indications

System OK

System under normal/safe operating condition.



- All outputs normal/off

System in ‘Pre-Alarm’ condition

When gas levels reach pre-alarm values.

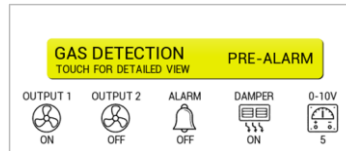

- Output-1 On
- Damper (Selectable On/Off)
- 0-10V output: 5v

System in ‘Alarm Delay’ condition

When gas reaches dangerous alarm values.

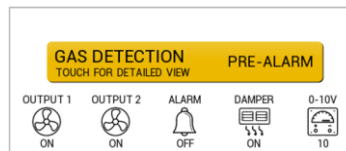

- Output-1 On
- Output-2 On
- Damper (Selectable On/Off)
- 0-10v output: 10v

System in Alarm condition

Gas levels beyond the alarm delay condition.



- Output-1 On
- Output-2 On
- Alarm On
- Damper On
- 0-10v output: 10v
- Gas detector ID shown
- Internal buzzer will sound

Temperature Indication

 All outputs will remain active until the temperature (monitored by ParkSafe detectors drops below 4°F of the specified threshold – adjustable in the configuration settings).

Temperature Status & Icon*

Temperature has exceeded pre-set value.



- Output-1 On
- Output-2 On
- Damper On
- 0-10v output: 10v

Silence & Reset Buttons

To silence the internal buzzer in alarm – press the Silence button on the front of the controller. This will also silence any external audio strobe/sounders connected to the controller.

If the system reaches alarm condition – the controller will need resetting when the gas levels return to a safe concentration. Check the detector status to identify the gas detected and if levels have returned to a safe condition - reset the system.

Gas Detection Status Information

To access detector status screens, press the 'Gas Detection' section on screen any time. Switch between pages by touching the relevant page button at the bottom of the screen.

Each page will display up to four ParkSafe detectors:



a	b	c	d	e
ID	Serial Number	Gas	Status	Value
9	123456789103	CO	GOOD	2 ppm
10	123456789103	H	GOOD	0.4 LEL%
11	123456789103	CO	GOOD	47 ppm
12			---X---	

- a. The ID configured via switches on each detector board.
- b. The unique serial number for that detector.
- c. The target gas that detector is monitoring.
- d. The status of gas levels, errors, and messages.
- e. The concentration value of gas detected.

To return to the main screen, press the home button on screen.

Detector Status Meaning

- GOOD** ○ Gas levels are safe / No error conditions.
- PRE-ALARM** ○ Gas detected has reached pre-alarm levels.
- ALARM** ○ Gas detected has reached alarm levels.
- FAULT** ○ Gas sensor module has an issue (Removed or not properly installed).
- END OF LIFE** ○ The gas-sensing element has reached the end of its expected lifecycle.
- SERVICE** ○ Gas sensing element requires annual periodic bump test.
- X --** ○ Detector signal lost, not installed or not configured correctly.

ParkSafe Detector Alarm Set Points

▲ Rising alarm
ppm (Parts per Million)

Detector Type	Pre-Alarm	Alarm
Carbon Monoxide (CO)	▲ 25ppm	▲ 100ppm
Nitrogen Dioxide (NO2)	▲ 0.7ppm	▲ 2.0ppm

Modbus Communication Rescan

At any time, the user can rescan and refresh the Modbus communication data if there is a bad connection in the chain by pressing the icon on screen.



When pressed the system will search for all signals connected to the controller i.e., gas detectors without the need to reset the system.

Maintenance



Cleaning

-  Concentrations of alcohol found in many products may damage, deteriorate, or affect the gas sensing elements such as wine; deodorants; stain removers and thinners. Other gases and substances to avoid are corrosives (i.e., chlorine & hydrogen chloride); alkali metals; basic or acidic compounds; silicones; tetraethyl lead; halogens and halogenated compounds!

Keep your ParkSafe controller and detectors in good working order

- Remove any dust/debris from the outer enclosures regularly using a slightly damp cloth.
- Never use detergents or solvents to clean your device(s).
- Never spray air fresheners, hair spray, paint or other aerosols near the detectors.
- Never paint the device(s). Paint will seal vents and interfere with the equipment.

Manual Circuit Simulation Test

-  Access to the interior of the detector, when carrying out any work, must be conducted by a competent person!
-  This circuit test does not check the gas sensing element itself!

When the test button on the ParkSafe detector circuit board is pressed and held, it will simulate an open circuit to ensure all configured systems, outputs, alarms, indications, and other external devices operate as intended in response to dangerous levels of gas.

When the button is released – the test sequence will terminate and return to normal operation.

Annual Service Message

-  The annual service message timer will begin after five (5) hours of continuous power irrespective of whether the system is then used intermittently!







EOL or SERVICE REQUIRED

A service message will appear on the ParkSafe controller home screen after one year of any connected ParkSafe detector operation. The detector will still operate during this time, but you should contact your supplier immediately.

We recommend that the system is serviced/bump tested at least annually from the date of installation for optimum performance and protection due to sensitivity drifts. Enter the status screens on the controller to determine if the ParkSafe detector requires a [Service] or if it has reached its [End of Life].

End of Operational Life (EOL)

-  The EOL is approximate from the first five (5) hours of continuous power!
-  The EOL will depend on the type of gas your detector is targeting and may vary depending on its application and environmental conditions such as the frequency of exposure to the target gas, poisons, or inhibitors!
-  At the end of their working life, electrochemical sensors for PARKSAFE detectors should be disposed of in an environmentally safe manner. Alternatively, all detectors can be securely packaged and returned to AGS clearly marked for disposal.
-  Electrochemical sensors should not be incinerated as this may cause the cell to emit toxic fumes.

Enter the status screens on the controller to determine if the ParkSafe detector requires a [Service] or if it has reached its [End of Life]. End of Life means the detector will need replacing and the Detector 'Fault' LED will remain illuminated. The typical life of a ParkSafe detector depends on its application, environment and intended target gas. In addition, the operational life may be prolonged if the equipment is installed and maintained in accordance the instructions stated within this manual.

Bump Testing (Gas Response Check)

⚠ **All certified test gases supplied by AGS are classified as non-flammable and non-toxic, however, they may contain gas under pressure and may explode if heated to extreme temperatures and cause asphyxiation in high concentrations. Always use in accordance with the safety data sheet!**

Gas response checks are often referred to as a 'bump test'. Bump tests are important to make sure a device can detect a release of gas as early as possible. The aim of the bump test is to make sure a detector is working at its optimum by briefly exposing the unit to a known concentration of the target gas that usually exceeds the highest alarm point. If the detector goes into alarm and all signals/outputs activate, then the system is working. If the system fails to operate as intended in an alarm state, the gas detector must not be used until a full inspection and service has been conducted. NFPA requires all gas detectors to be tested annually and that the test results be recorded on site and available to inspectors.

A detector may visually appear in good working order, but its sensitivity and accuracy can be inhibited by external factors. Dust, humidity, temperature fluctuations, cleaning products, contaminants, exposure to its target gas or sensor drift (ageing) can cause a decline in sensitivity, accuracy, and eventual failure.

Regular bump tests are important to make sure the detector can detect a release of gas as early as possible and usually takes seconds (gas type dependant i.e., CO sensors will take over a minute) and is often completed alongside a scheduled fire alarm test, however the frequency should be determined following an appropriate risk assessment by the end user.

We recommend testing detectors every 12-18 months along with the regular fire test procedures and coincide with the annual service message prompted on the detection system after each year of service/operation.

Contact your AGS representative for details of suitable bump testing kits and gases. Kits usually consist of a certified gas cylinder or spray. We recommend only using AGS calibration gas kits to ensure correct flow rates meet AGS technical requirements. A bump testing gas is usually a concentration mix that exceeds the highest alarm set point.

Bump Test Procedure

- ⚠ **Step 1 will enable service mode and inhibit all alarms/outputs and signals for fifteen (15) minutes!**
- ⚠ **If you are testing all actuation of alarms/outputs and signals, please proceed to Step 2!**
- ⚠ **The controller will return to a normal operational state after fifteen minutes automatically unless service mode is disabled manually by pressing the [Exit] button on screen!**
- ⚠ **Always give at least five (5) minutes between testing the same unit or until gas has fully dispersed!**
- ⚠ **If Service mode is activated – reset the system after completing the bump tests!**
- ⚠ **Pressing silence on the controller will silence the internal buzzer when in alarm!**

Step 1. Activate Service Mode

- Access service mode by pressing the AGS logo on the controller (home screen logo only).
- The screen will display a service message prompt.
- Press Yes. (Note: All alarm signals/outputs will be inhibited for fifteen (15) minutes).
- Proceed to test gas detectors.
- Upon completion – exit service mode by pressing the 'Exit' button on screen.



Step 2. Test Detector

- ⚠ Access to the interior of the detector, when carrying out any work, must be conducted by a competent person!
- ⚠ Apply a gas concentration ~50% higher than the alarm setpoint but do not exceed the upper limit of measurement!

- Ensure you have the correct calibration gas for the device type.
- If using a cylinder - screw the regulator/valve into the gas cylinder outlet.
- Offer up the applicator hose/cone and fully cover the sensing element on the front case.
- Open the valve/regulator to allow the gas to be delivered at a pre-set flow rate.
- Apply gas to the gas inlet holes on the front of the detector housing.
- The detector 'Alarm' LED will illuminate at the alarm setpoint.
- The Controller will activate all configured outputs/relays (unless service mode is activated) and will display the gas concentration detected.
- Remove applicator hose/ cone and turn the gas cylinder regulator/valve off.
- Wait for detector to stabilise / return to normal.
- Reset the service reminder by tapping the circuit test button 3 times (within 2 seconds)
- Test complete.
- Record your test details.



Specification

General	
Model:	ParkSafe Controller
Capacity:	Up to 16 channels per controller unit.
Size: (H x W x D)	7.08 x 10.03 x 3" (180 x 255 x 77 mm)
Housing Material:	ABS Polylac - PA765. UL 94 V-1
Mounting:	Indoor use - Wall Mounting
Weight:	1.3kg (2lb 13.85oz)
User Interface	
Display:	4.3" TFT Touch Screen
Screen Brightness:	Adjustable 0-100%
Visual Indicators:	TFT visual. Green: Normal; Yellow: Pre-Alarm; Amber: Alarm Delay; Red: Alarm Relay Outputs On/Off Gas Detection Status.
Audible Alarm:	>70dB @ 3.28ft (1m). Quiet conditions.
Buttons:	Common for Silence/Reset operation.
Language:	English
Power Supply	
Power Consumption:	14.5W max.
AC Power:	100-120V~ 50/60Hz
Internal Fuse:	T3.15A L250V
Equipment	
Overvoltage Category:	II
Pollution Degree:	2
Equipment Class:	2
I/O	
Relay Output:	Volt Free Relay Outputs x4 (non-latching). NO/C/NC 6A @ 120V~ User configurable – energised/de-energised, time delay. 24 VDC switching.
Common Output:	24 VDC Permanent. 0-10 VDC Variable.
Environmental	
Ingress Protection:	Not Formally Evaluated
Operating:	-10 ~ 50°C / 14 ~ 122°F 30 ~ 80% RH (non-condensing)
Storage:	-25 ~ 50°C / -13~122F° up to 95% RH (non-condensing)
Altitude Rating:	2000m
Wiring	
Typical	Power~#18-12AWG-Tinned Copper. Current Rating: 1A Minimum. Voltage:100-250V~. Wire Stripping Length 6-7mm Relay: ~#18-12AWG-Tinned Copper. Current Rating: 10A Minimum. Voltage: 100-250V~ Wire Stripping Length 6-7mm For field connections use wires suitable for at least 90°C (194°F) Detector: #15AWG Power Pair #18AWG Data Pair-Tinned copper. Other: #18-14AWG-Tinned Copper.
Approvals	
Electromagnetic Compatibility and Electrical Safety	IEC 61010-1:2010 + AMD1:2016; EN 61010-1:2010 +A1:2019; UL61010-1/2012/R:2019-07; CAN CSA C22.2 No. 61010-1-12/A1:2018-11 EMC EN 61326-1:2013
Other	
Communication	RS485 MODBUS RTU

Installation Details

Please pass this manual to the system owner / user.

Date of Installation:	
Installation Location:	
Organisation:	
Stamp/Signature of the installer:	

We recommend all AGS gas detection equipment be commissioned by competent/trained engineers to ensure correct installation and operation. The Merlin range of gas detectors are calibrated when manufactured, however, we strongly recommend the detectors response and alarm signals are tested and validated once installed. This will ensure the equipment performs as intended and is free from any unforeseen damage caused by transit/installation.

Every effort is made to ensure the accuracy of this document; however, AGS can assume no responsibility for any errors or omissions in this document or their consequences. AGS would greatly appreciate being informed of any errors or omissions that may be found in the content of this document. For information not covered in this document, or if there is a requirement to send comments/corrections, please contact AGS using the contact details.

Find out more

American Gas Safety LLC

www.americangassafety.com

Head office:

6304 Benjamin Road, Suite 502, Tampa, FL 33634

Tel: (727) 608-4375

Email: info@americangassafety.com



American Gas Safety LLC is the owner of this document and reserves all rights of modification without prior notice.