

12in x 12in x 6in

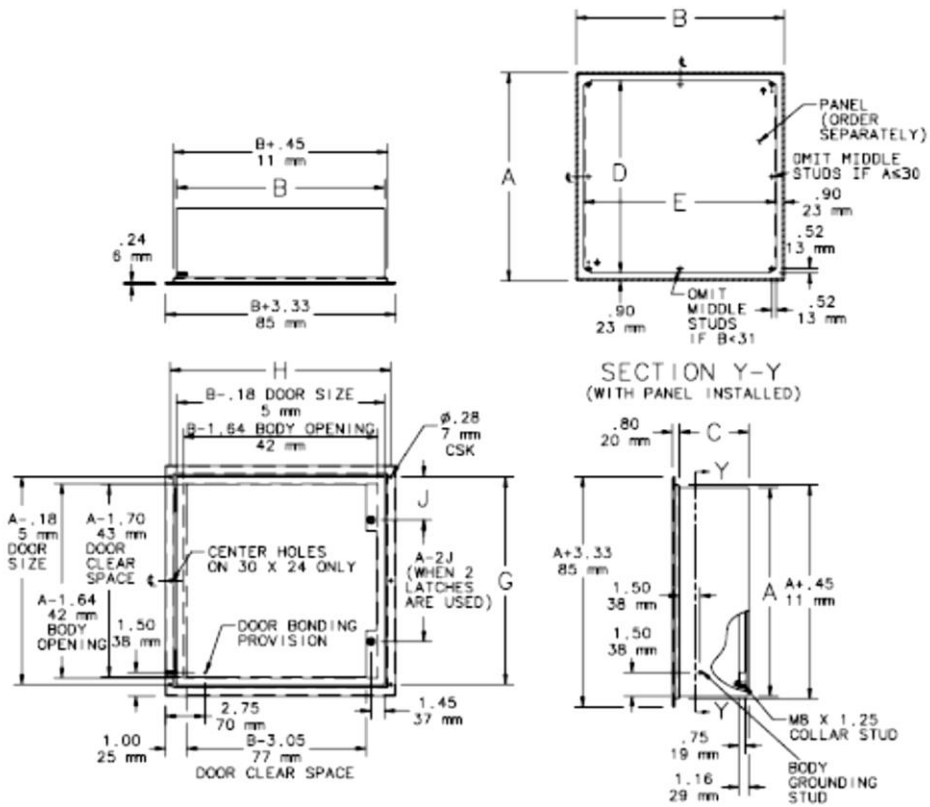

Specifications:

- 16 gauge steel
- Seams continuously welded and ground smooth
- Corner-formed doors
- Simple easy-to-remove and install hinge pins with built-in captivation clip
- High-torque threadless studs and fasteners on door
- Minimum-width body flange provides maximum door opening (210 degrees)
- Door opens 210 degrees
- External formed body flange
- Panel mounting studs fit optional panels and other accessories
- Mounting holes in back of body for optional external wall-mount brackets
- Removable door with hidden hinges for clean, aesthetic appearance
- Seamless foam-in-place gasket
- Quarter-turn slotted latch(es)
- Grounding stud on body; bonding provision on door
- Hardware kit with panel mounting nuts, panel grounding hardware and sealing washers
- Installation instructions provided
- Flush-Mount models have a mounting frame that extends completely around the enclosure



AxBxC in./mm	Finish	Door Ga.	Body Ga.	CONCEPT Panel	CONCEPT Panel	D x E in./mm	G x H in./mm	Latches qty.	Latches style	J in./mm
12.00 x 12.00 x 6.00 305 x 305 x 152	RAL 7035 Lt. Gray	16	16	CP1212	CP1212G	10.20 x 10.20 259 x 259	12.75 x 14.25 324 x 362	1	Quarter-turn	6.00 152

UL 508A Listed; Type 4, 12; File No. E61997
 cUL Listed per CSA C22.2 No. 94; Type 4, 12; File No. E61997

NEMA/EEMAC Type 4, 12, 13
 CSA, File No. 42186: Type 4, 12
 VDE IP66
 IEC 60529, IP66

Finish
 RAL 7035 textured light gray polyester powder paint inside and out



AGS Head Office

Tel: (727) 608-4375

Fax: (727) 538-4237

info@americangassafety.com